

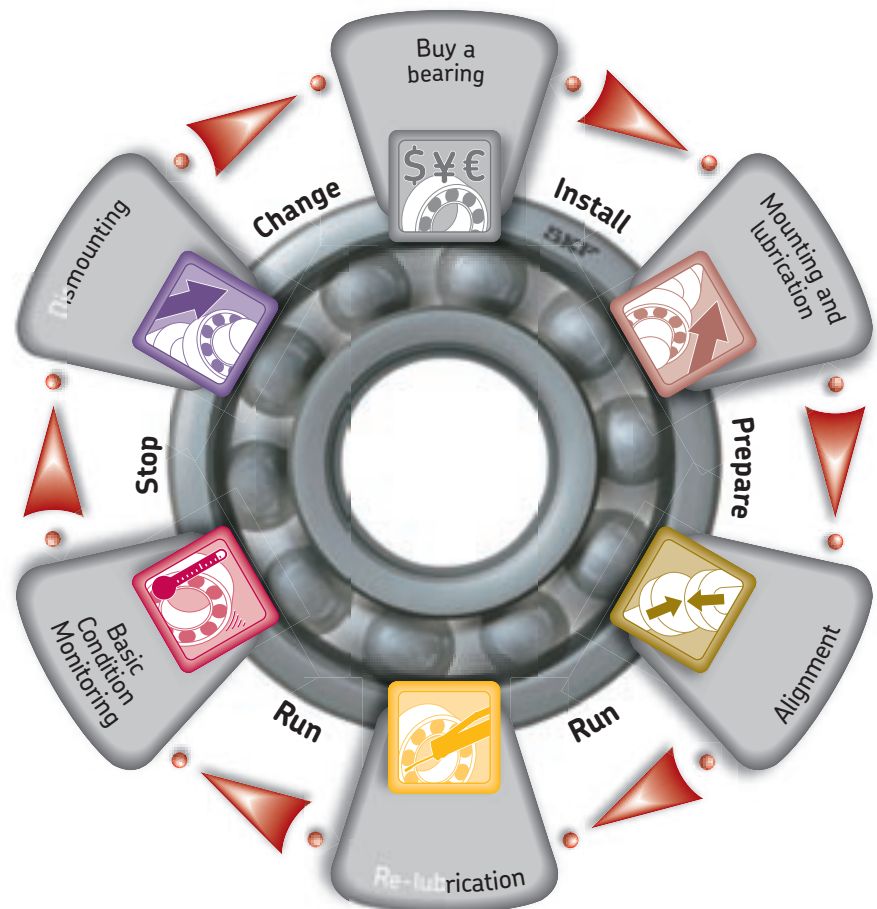

# SKF Maintenance and Lubrication Products



Extending the Bearing Life Cycle

# SKF Maintenance and Lubrication Products

7



Mounting and lubrication

41



Alignment

49



Re-lubrication

77



Basic condition monitoring

91



Dismounting

111

SKF Support

114

Technical data

143

Designation index

# The SKF Bearing

## Help your bearing achieve its maximum

Every bearing has a pre-calculated service lifetime. However, research has shown that for various reasons, not every bearing achieves it. Important stages, which have a major impact on a bearing service lifetime can be recognised during the bearing's lifecycle. These stages are mounting and lubrication, alignment, re-lubrication, basic condition monitoring and dismantling.

The stages in a bearing life cycle are extremely important for achieving the maximum service life of the bearing.

By applying the right maintenance practices and using the correct tools, you can considerably extend your bearing's service life and increase plant productivity and efficiency.

### Mounting and lubrication



#### Includes mechanical fitting tools, induction heaters and hydraulic equipment

Mounting is one of the critical stages of the bearing's lifecycle. If the bearing is not mounted properly using the correct method and tools, the bearing's service lifetime will be reduced. Lubrication is also an important step in the mounting procedure. Selecting bearing grease suitable for the application is critical to achieving optimum performance. Additionally, the quantity of grease and the lubrication method used can positively influence the service life of the bearing.

### Alignment



#### Includes shaft and belt alignment tools and machinery shims

After the bearing has been mounted in an application, such as a motor connected to a pump, the application should be aligned. If the application is not properly aligned, the misalignment can cause the bearing to suffer additional load, friction and vibration. These can accelerate fatigue and reduce the bearing's, as well as other machine components, service life. Furthermore, increased vibration and friction can significantly increase energy consumption and the risk of premature failures.

### Re-lubrication



#### Includes bearing greases, manual and automatic lubricators and lubrication accessories

When operating, the bearing requires correct re-lubrication practices to optimise its performance. Selecting bearing grease suitable for the application and applying the right quantities at correct intervals are essential for achieving the maximum service life of the bearing. Additionally, the re-lubrication method used can positively contribute to optimising the bearing's service life. Continuous lubrication using automatic lubricators, single or multiple-point, provides more consistent, correct and contamination-free grease supply than manual re-lubrication methods.

### Basic condition monitoring



#### Includes temperature, noise, speed and vibration measuring instruments

During operation, it is important to regularly inspect the condition of the bearing by performing basic condition monitoring, such as temperature, vibration and noise measurements. These regular inspections will allow the detection of potential problems and help to prevent unexpected machine stops. Consequently the machine maintenance can be planned to suit the production schedule, increasing the plant's productivity and efficiency.

# Life Cycle

service lifetime

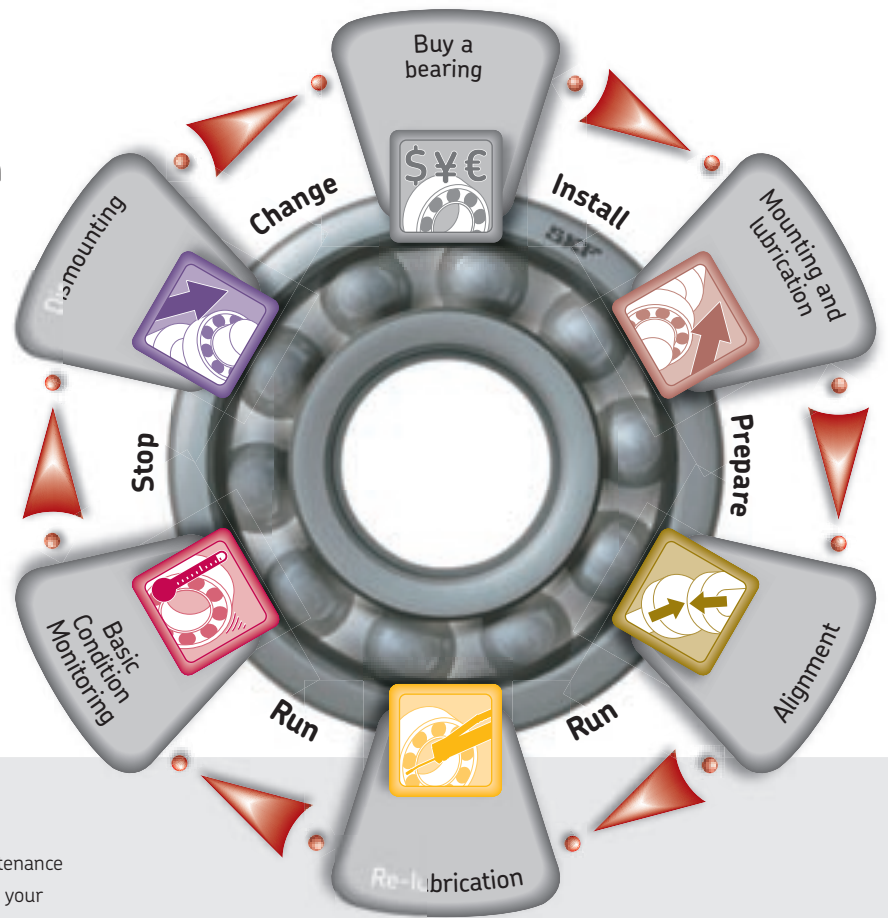

## How to use this catalogue

Inside this catalogue you will find SKF's complete range of maintenance products, which can help you get the maximum service life from your bearings. Products included in this catalogue are arranged according to the stages of the bearing life cycle: Mounting and Lubrication, Alignment, Re-lubrication, Basic Condition Monitoring and Dismounting. To help you locate the product you need as easily as possible, we have developed the following quick reference guide:

For more information about SKF maintenance products or to order any of these products, please contact your local SKF authorised distributor or SKF sales company. On the Internet, SKF can be found at [www.skf.com](http://www.skf.com). SKF Maintenance Products can be found at [www.mapro.skf.com](http://www.mapro.skf.com).

## Dismounting



**Includes pullers, both mechanical and hydraulic, induction heaters and hydraulic equipment**

At some point, the bearing will reach the end of its service life and will have to be replaced. Although the bearing may not be used again, it is extremely important to dismount it correctly so that the service life of the replacement bearing is not compromised. Firstly, the use of proper dismounting methods tools will help prevent damage to other machine components, such as the shaft and housing, which are often re-used. Secondly, incorrect dismounting techniques can be hazardous to the operator.



Found next to a product: Indicating that this product is a new addition to the SKF range



Located next to each product: Indicates on which page you can find the technical data and ordering details for that product

**Technical data and Ordering details:** Located on pages 114 – 142 provides the complete list of technical data and ordering details per product

**Designation index:** Located on pages 143 – 144 lists all products by designation followed by product description in alpha-numerical order

# Prevent over 60% of premature bearing failures



**16%** **Poor fitting**

Around 16% of all premature bearing failures are caused by poor fitting (usually brute force...) and being unaware of the availability of the correct fitting tools. Individual installations may require mechanical, hydraulic or heat application methods for correct and efficient mounting or dismounting. SKF offers a complete range of tools and equipment to make these tasks easier, quicker and more cost effective, backed up by a wealth of service engineering know-how. Professional fitting, using specialised tools and techniques, is another positive step towards achieving maximum machine uptime.



**36%** **Poor lubrication**

Although 'sealed-for-life' bearings can be fitted and forgotten, some 36% of premature bearing failures are caused by incorrect specification and inadequate application of the lubricant. Inevitably, any bearing deprived of proper lubrication will fail long before its normal service lifespan. Because bearings are usually the least accessible components of machinery, neglected lubrication frequently compounds the problem. Wherever manual maintenance is not feasible, fully automatic lubrication systems can be specified by SKF for optimum lubrication. Effective lubrication, using only recommended SKF greases, tools and techniques, helps to significantly reduce downtime.



**14%** **Contamination**











































A bearing is a precision component that will not operate efficiently unless both the bearing and its lubricants are isolated from contamination. And, since sealed-for-life bearings in ready-greased variants account for only a small proportion of all bearings in use, at least 14% of all premature bearing failures are attributed to contamination problems. SKF has an unrivalled bearing manufacturing and design capability and can tailor sealing solutions for the most arduous operating environments.













**34%** **Fatigue**

Whenever machines are overloaded, incorrectly serviced or neglected, bearings suffer from the consequences, resulting in 34% of all premature bearing failures. Sudden or unexpected failure can be avoided, since neglected or overstressed bearings emit 'early warning' signals, which can be detected and interpreted using SKF condition monitoring equipment. The SKF range includes hand-held instruments, hard-wired systems and data management software for periodic or continuous monitoring of key operating parameters.

# SKF methods and tools

Bearing arrangements		Mounting tools				Dismounting tools			
		Mechanical	Hydraulic	Oil injection	Heaters	Mechanical	Hydraulic	Oil injection	Heaters
<b>Cylindrical seating</b> 	Small bearings								
	Medium bearings								
	Large bearings Cylindrical roller bearing types NU, NJ, NUP, all sizes								
<b>Tapered seating</b> 	Small bearings								
	Medium bearings								
	Large bearings								
<b>Adapter sleeve</b> 	Small bearings	 							
	Medium bearings								
	Large bearings								
<b>Withdrawal sleeve</b> 	Small bearings								
	Medium bearings								
	Large bearings								

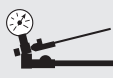
Small bearings: Bore diameter < 80 mm / Medium bearings: Bore diameter 80 – 200 mm / Large bearings: Bore diameter > 200 mm / \* Only for self-aligning ball bearings.

Key										
Jaw puller	Bearing separator	Hydraulic puller	Fitting tool	Hook spanner	Impact spanner	Hydraulic nut and pump	Drive-up Method	Oil injection method	Hot plate Induction heater	Aluminium ring EAZ heater
										

# The Maintenance Challenge: Achieving More with Less

Today maintenance managers face a difficult task: Although their staff members are highly competent, there are often fewer of them than in the past. Consequently, each one has a larger group of machines to look after and so may not be able to follow precision maintenance practices. In addition, equipment maintenance is becoming more complicated because of ongoing technical advances, and environmental and safety laws are increasingly strict, placing more pressure on this function than ever before.

Despite all these challenges, maintenance personnel are driven by management to maximise machine uptime to increase productivity – often with a reduced budget.



## From cost centre to profit centre

Recognising the need for supplemental resources, SKF has focused on combining its broad range of products and industry knowledge to address specific plant maintenance and reliability needs. Our goal is to help our customers manage maintenance costs more effectively to reduce cost and increase productivity.

By combining its knowledge of bearings, seals, lubrication, maintenance, and condition monitoring, SKF will research, design and implement solutions that go beyond corrective maintenance. Depending on need, customers can either choose stand-alone services, such as Shaft Alignment, Lubrication Analysis, and Precision Balancing or combine them into an all-inclusive contract strategy.

*The bearing maintenance tools and instruments shown in this catalogue are key components in the solutions mix. Whether used by maintenance personnel or by an SKF Reliability Systems technician, they provide the means to safe and damage-free component installation and dismantling.*

## SKF capabilities include, but are not limited to:

- Asset management strategy and consulting
- Reliability maintenance solutions and service
- Mechanical maintenance services
- System installation and management services

*For more information about SKF solutions, contact your local SKF representative, or visit [www.skf.com/reliability](http://www.skf.com/reliability).*





# Mounting and Lubrication

## Mounting

### Mounting bearings in a cold condition

Interference fits: cylindrical shafts	9
Interference fits: tapered shafts	10
Anti-fretting agent LAGF 3E	10
Bearing fitting tool kit TMFT 36	11
Bearing lock nut spanner TMHN 7 series	13
Hook spanners HN series	13
Adjustable hook spanners HNA series	13
Hook spanners HN ..SNL series	14
Impact spanners TMFN series	14
Axial lock nut sockets TMFS series	15
Bearing handling tool TMMH series	15

### Mounting bearings using heat

SCORPIO induction heater TMBH 1	16
Electric hot plate 729659 C	17
Portable induction heater TIH 030m	17
Induction heater TIH 100m	18
Large induction heater TIH 210m	19
Induction heater trolley TIH T1	20
Special heaters for large components	21

### Mounting bearings using hydraulic techniques

The SKF Oil Injection Method	22
SKF Oil Injection Method CD-ROM	22
The SKF Drive-up Method	23
Hydraulic nut drive-up adapter HMVA 42/200	24
Drive-up Method CD-ROM	25
Adapter and withdrawal sleeves for oil injection	25
Hydraulic nuts HMV ..E series	26
Feeler gauges 729865 series	27
SensorMount® indicator TMEM 1500	27
Hydraulic pumps and oil injectors selection guide	28

Hydraulic pump 729124	29
Hydraulic pump TMJL 100	29
Hydraulic pump TMJL 50	30
Hydraulic pump 728619 E	30
Air-driven hydraulic pumps, THAP series	31
Screw injectors 226270 and 226271	31
Oil injector 226400 series	32
Oil injection kits 729101 series	32
Oil injection sets TMJE 300 and 400 series	33
Adapter block 226402	33
High-pressure pipes	34
Pressure gauges	34
Plugs for oil ducts and vent holes	34
Flexible high-pressure hoses	34
Quick connecting coupling and nipples	35
Connection pipes with metric and G pipe threads	35
Connection nipples with NPT tapered threads	35
Extension pipes with connecting nipples	36
Mounting fluid LHMf 300	36
OK coupling mounting and dismantling kits	37

### Accessories

Anti corrosive agent LHRP 1	38
Special working gloves TMBA G11W	38
Heat resistant gloves TMBA G11	38
Extreme temperature gloves TMBA G11ET	39
Heat and oil resistant gloves TMBA G11H	39

## Lubrication

SKF bearing greases	40
---------------------	----





## Mounting

### Prevent 16% of premature bearing failures

Around 16% of all premature bearing failures are a result of poor fitting or using incorrect mounting techniques. Individual applications may require mechanical, heat or hydraulic mounting methods for correct and efficient bearing mounting. Selecting the mounting technique appropriate for your application will help you extend your bearing's service life and reduce costs resulting from premature bearing failure as well as potential damage to the application.

### Mounting bearings in a cold condition

Small and medium size bearings are generally cold mounted. Traditionally the bearing is mounted using a hammer and a length of old pipe. This practice can cause forces to be transmitted through the rolling elements, causing damage to the raceways. SKF fitting tools help prevent bearing damage by applying the forces to the bearing ring with the interference fit.

### Mounting bearings using heat

Oil baths are often used for heating bearings prior to mounting. However, this method can contaminate the bearing, resulting in premature bearing failure. Today, induction heating is the most common technique for heating bearings since it allows a high degree of controllability, efficiency and safety. SKF has set the standards for the development of induction heaters for bearing applications. SKF bearing induction heaters are equipped with many features, which help prevent bearing damage during heating.

### Mounting bearings using hydraulic techniques

SKF has pioneered the use of hydraulic techniques, such as the SKF Oil Injection Method and the SKF Drive-up Method, for mounting bearings. These techniques have helped to simplify bearing arrangements and facilitate correct and easy mounting. SKF has also developed a comprehensive range of tools and equipment to put these hydraulic techniques into effect.

### Online mounting and dismounting instructions

At [skf.com/mount](http://skf.com/mount), SKF offers a unique Web-based, free of charge information service for the mounting and dismounting of SKF bearings and bearing housings in eight languages. This service provides step-by-step instructions for mounting or dismounting. The system also provides information on proper tools and lubricants. With this free Internet based service; SKF's expertise is at your fingertips around the clock worldwide.



# Mounting bearings in a cold condition

Premature bearing failure can result from damage incurred when a bearing is incorrectly mounted

Typical problems that can cause premature failures are:

- Damage caused during the fitting procedure
- Incorrect sized shafts and housings i.e. too loose or too tight
- Retaining lock nuts coming loose in operation
- Burred and damaged shaft and housing seats and shoulders
- Incorrectly mounted bearings

## Interference fits: cylindrical shafts

Most bearings are fitted to their shaft or housing with one component having an interference fit. For determining the correct fit, refer to the SKF General Catalogue, the SKF Maintenance Handbook or consult an SKF application engineer.



### Incorrect mounting

When bearings are mounted cold, care must be taken to ensure the drive-up forces are applied to the ring with the interference fit. Damage and a resulting bearing failure can occur if the mounting force is transmitted through the rolling elements causing damage to the raceways.

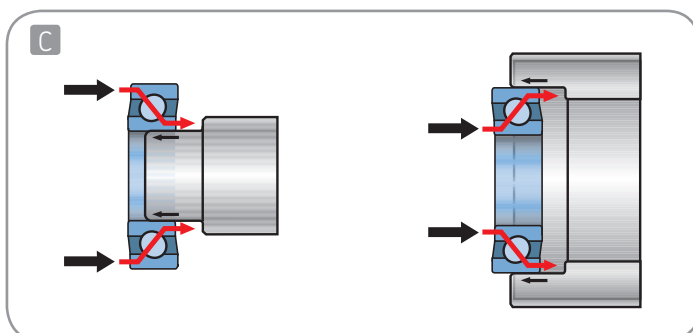
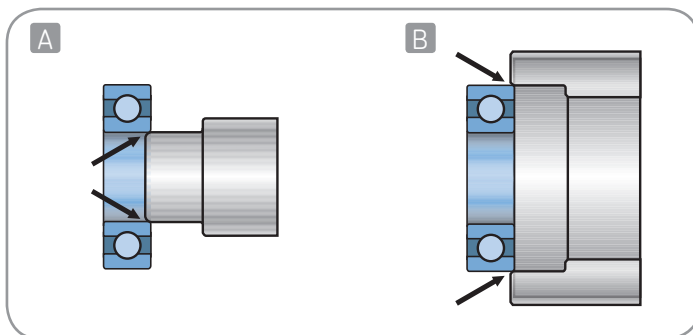

### Correct mounting

The correct way to minimise raceway damage is to use the specifically designed tools from SKF, such as the TMFT 36 fitting tool kit. These tools allow drive-up forces to be applied effectively and evenly to the component with the interference fit avoiding raceway damage.

- A Shaft interference fit
- B Housing interference fit
- C Uneven distribution of forces can result in raceway damage
- D With the correct tools raceway damage is avoided

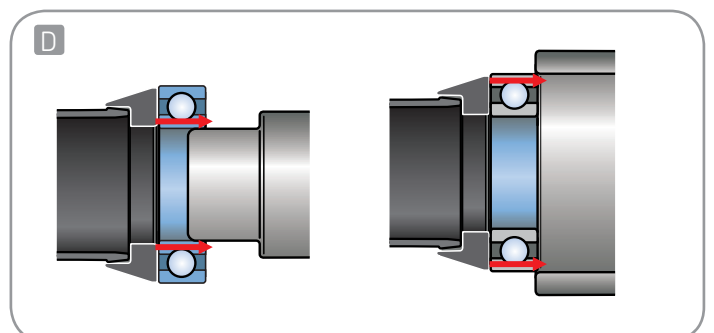



# Mounting and lubrication



## Interference fits: tapered shafts

Bearings mounted on tapered seatings achieve their interference fit by being driven up the tapered shaft. Care should be taken to ensure the bearing is not

driven up too far, as all the internal clearance may be removed and damage to the bearing is possible.

### Spherical roller bearings

**Method:** Correct adjustment of spherical roller bearings is determined by measuring the residual internal clearance in the bearing or by the amount of axial drive-up. Details of the required reduction of clearance and axial drive-up can be obtained from tables published in the SKF General Catalogue. For larger size bearings, it is generally recommended to consider using a tapered seating to facilitate easy mounting and dismounting.

### Self-aligning ball bearings

**Method:** Adjustment of double row, self-aligning ball bearings is more difficult to achieve than spherical roller bearings because the feeler gauge method cannot be used. A very effective method to mount this type of bearing correctly is to use the SKF TMHN 7 lock nut spanner set.

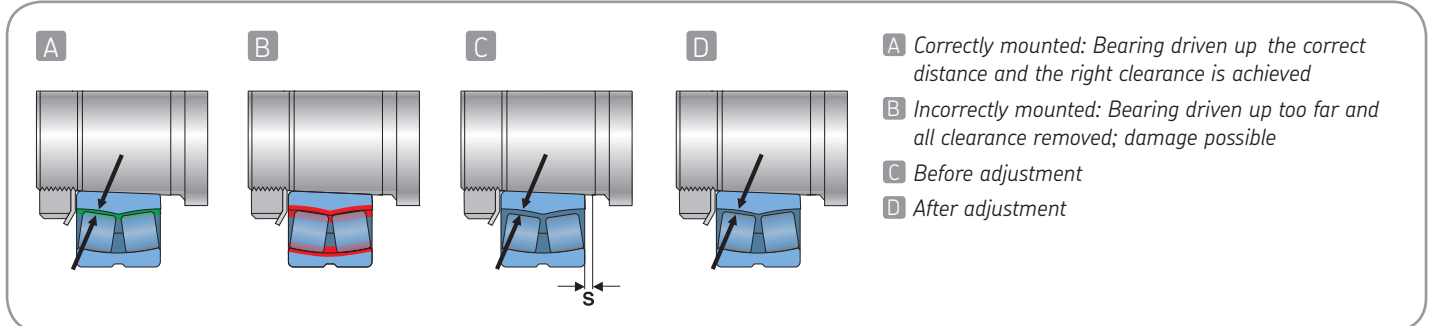
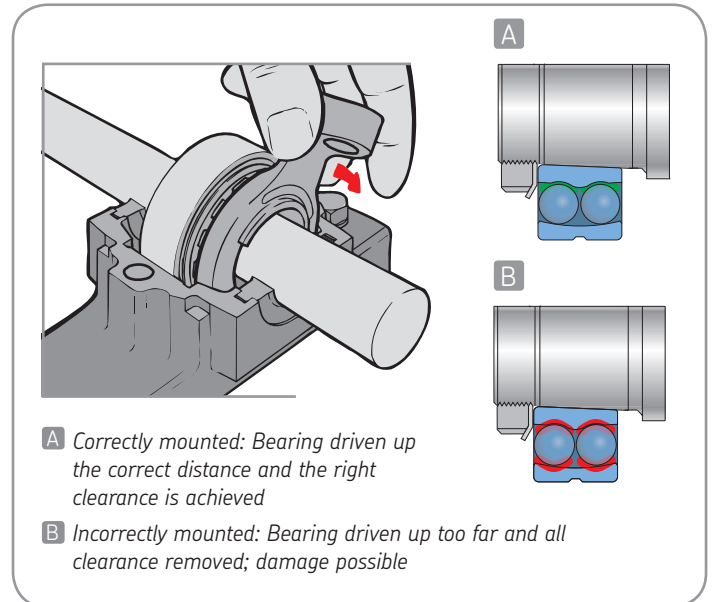

## SKF anti-fretting agent LGAF 3E

SKF LGAF 3E is a greasy, smooth paste especially developed to prevent fretting corrosion between metal surfaces in loose fit arrangements. Fretting corrosion is caused by very slight oscillations or by vibrations, which may lead to serious

damage in bearings and other machine parts and can make dismounting almost impossible.

- Reduction of fretting corrosion providing easier dismounting of bearings
- Better sliding on designed loose bearing arrangements such as vibrating screens, truck and car wheel bearings
- Easier removal of general industrial components in a wide range of applications such as nuts, bolts, flanges, studs, bearings, guide pins, couplings, jack screws, lathe centres, push rods, and spline shafts



# SKF bearing fitting tool kit TMFT 36



## Prevent 16% of premature bearing failures

Poor fitting, usually using brute force, accounts for 16% of premature bearing failures. The SKF bearing fitting tool kit TMFT 36 is designed for quick and precise mounting of bearings, while minimising the risk of bearing damage. The right combination of impact ring and sleeve allows effective transmission of mounting force to the bearing ring with the interference fit, minimising the risk of damaging the

- 36 impact rings in different sizes facilitate the mounting of more than 400 different bearings
- Facilitates correct mounting on shaft, housing and blind applications
- The diameter of the impact ring perfectly fits the inner and outer diameter of the bearing
- Small diameter of the impact area on top of the sleeve allows effective transmission and distribution of mounting force
- Impact rings and sleeves are made of high-impact resistant material for longevity
- Click connection between impact ring and sleeve provides stability and durability
- The impact rings are suitable for use under a press
- Impact rings are marked for clear visual identification of the ring's size and easy selection
- Even surface of the impact sleeve's body provides excellent grip
- The nylon double-side head of the dead-blow hammer helps to prevent damaging the components
- The rubber handgrip of the dead-blow hammer provides excellent grip

bearing's raceways or rolling elements. The kit contains 36 impact rings, 3 impact sleeves and a dead-blow hammer packed in a lightweight carrying case. In addition to mounting bearings, the TMFT 36 is also suitable for mounting other components such as bushings, seals and pulleys.

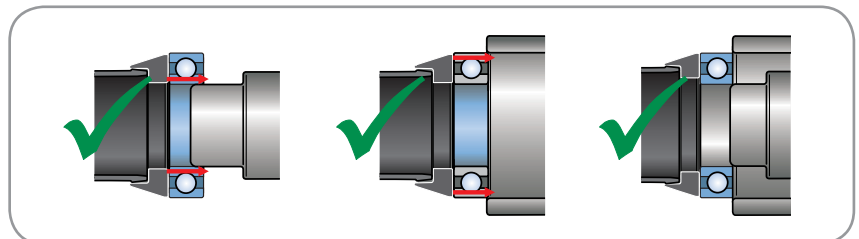
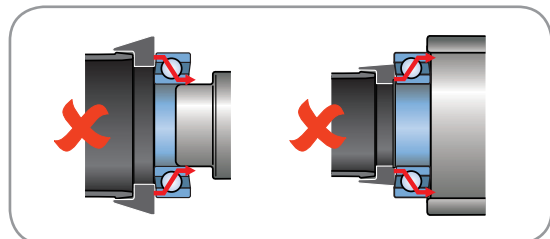



# Mounting and lubrication



TMFT 36 selection table

SKF bearing series

Sleeve	Rings																			
		60.. 63.. 16.. 63../ 98..	62.. 64.. 62../ 98..	622.. 623.. 630..	12.. 13.. 22.. 23..	72.. 73..	32.. 33.. 52.. 53..	213.. 222.. 223..	10.. 2.. 22..	3.. 23..	30.. 32..	31.. 33..	C22.. C40..	42.. 43..						
	10 / 26	629	63000	129																
	10 / 30	16100 6000 6200	63000	129																4200
	10 / 35	6300	62300																	
	12 / 28	6001 16101	63001																	
	12 / 32	6201	62201	1201	7201	3201														4201
	12 / 37	6301	62301	2201 1301 2301	7301	5201														4301
	15 / 32	16002 6002	63002																	
	15 / 35	6202	62202	1202	7202	3202		202												4202
	15 / 42	6302	62302	2202 1302 2302	7302	5202 3302 5302									30302					4302
	17 / 35	16003 6003	63003																	
17 / 40	98203 6203	62203	1203	7203	3203		203							30203					4203	
17 / 47	6303	62303	2203 1303 2303	7303	5203 3303 5203		303							30303 32303					4303	
	20 / 42	16004 98204 6004	63004																	32004
	20 / 47	6204	62204	1204	7204	3204		204						30204						4204
	20 / 52	6304	62304	2204 1304 2304	7304	5204 3304 5304	22205/20	304 2304 1005						30304 32304 32005						4304
	25 / 47	16005 6005	63005																	
	25 / 52	62/22 98205 6205	62205	1205	7205	3205	22205	205						30205 32205 33205	C 2205					4205
	25 / 62	63/22 6305 6403	62305	2205 1305 2305	7305	5205 3305 5305	21305	305 2305						30305 31305 32305						4305
	30 / 55	16006 6006	63006											1006						C 6006
	30 / 62	62/28 98206 6206	62206	1206	7206	3206	22206 B52-2206	206						30206 32206 33206	C 2206					4206
	30 / 72	63/28 6306 6404	62306	2206 1306 2306	7306	5206 3306 5306	21306	306 2306						30306 31306 32306						4306
	35 / 62	16007 6007	63007											1007						
35 / 72	6207	62207	1207	7207	3207	22207 B52-2207	207						30207 32207 33207	C 2207					4207	
35 / 80	6307 6405	62307	2207 1307 2307	7307	5207 3307 5307	21307	307 2307						30307 31307 32307						4307	
	40 / 68	16008 6008	63008																	
	40 / 80	6208	62208	1208	7208	3208	22208 B52-2208	208						32008 32008/38 30208 32208 33208	C 2208					4208
	40 / 90	6308 6406	62308	2208 1308 2308	7308	5208 3308 5308	21308 22308	308 2308						32307/37 30308 31308 32308 32009						4308
	45 / 75	16009 6009	63009											1009						
	45 / 85	6209	62209	1209	7209	3209	22209 B52-2209	209						30209 32209 33209	C 2209					4209
	45 / 100	6309 6407	62309	2209 1309 2309	7309	5209 3309 5309	21309 22309	309 2309						358 X 30309 31309 32309						4309
	50 / 80	16010 6010	63010											1010						C 4010
	50 / 90	6210	62210	1210	7210	3210	22210 B52-2210	210						30210 32210 33210	C 2210					4210
	50 / 110	6310 6408	62310	2210 1310 2310	7310	5210 3310 5310	21310 22310	310 2310						JM 205149 30310 31310 32310						4310
	55 / 90	16011 6011												1011						
55 / 100	6211	62211	1211	7211	3211	22211 B52-2211	211						30211 32211 33211	C 2211					4211	
55 / 120	6311 6409	62311	2211 1311 2311	7311	5211 3311 5311	21311 22311	311 2311						30311 31311 32311						4311	

## Bearing lock nut spanner TMHN 7 series

### For achieving the correct radial clearance

The TMHN 7 set of lock nut spanners is especially designed for mounting self-aligning ball bearings as well as small spherical roller and CARB® bearings on tapered seatings. Using the

- 7 different-sized spanners to fit nut sizes 5 to 11
- Each spanner is clearly marked with correct tightening angle and protractor
- 4 grip points on each spanner giving better and safer grip on the nut
- Reduced risk of damaging bearing by over-tightening
- Suitable for use with lock nuts of the KM series either on shaft or in SNL housings

TMHN 7 minimises the risk of over-tightening of the lock nut, which can result in removing the bearing's radial clearance and bearing damage.



114

## Hook spanners HN series

### Exact spanner radius reduces the risk of nut damage

The HN series includes 15 different size hook spanners based on the DIN 1810 standard. The hook spanners are designed for use with SKF KM nuts as well as any other KM nuts conforming to the DIN 981 standard. Additionally,

- Minimises the risk of shaft and nut damage
- Plastic handle is oil, grease and dirt resistant to provide a better grip
- The plastic handle minimises direct metal to skin contact, reducing the risk of corrosion in the handle area
- Hole in the spanner's handle facilitates easy storage
- Designation of spanner representing its size is laser-engraved allowing easy identification and selection

they are suitable for use with N, AN, KMK, KMFE and KMT as well as nuts manufactured according to the DIN 1804 standard.



114

## Adjustable hook spanners HNA series

### Four sizes for tightening or loosening up to 24 nut sizes

The SKF adjustable hook spanners HNA series facilitate the easy and safe tightening and loosening of KM, KML, N, AN,

KMK, KMFE and KMT nuts. The spanners are made of special hardened steel for durability.

- One hook spanner covers several nut sizes, making it suitable for use with many applications
- Economic solution: 4 hook spanners cover 24 nut sizes
- Laser engraved designation, which represents the range of nut sizes covered by the spanner, allows easy selection of the correct spanner
- Versatile: suitable for KM, KML, N, AN, KMK, KMFE and KMT nuts
- Hole in the spanner's handle facilitates easy storage
- Minimises the risk of shaft and nut damage



115



## Mounting and lubrication



### Hook spanners HN ../SNL series

#### Easy and quick bearing mounting and dismounting in SNL housings

A normal design HN hook spanner cannot be used in a SKF SNL housing, however the hook spanners of HN ../SNL series are especially designed to facilitate easy and quick mounting and dismounting of bearings with tapered bore on adapter sleeve in SKF SNL bearing housings. They are also suitable for tightening and loosening a wide variety of locknuts in both housing and shaft applications. The HN ../SNL series consists of 16 sizes suitable for nut outer diameter ranging from 38 to 145 mm (1,5 to 5,7 in). The spanners are made of hardened high quality chrome vanadium steel for durability.



116

- Unique, special design allows the HN ../SNL series to be used inside SKF SNL and SNH bearing housings
- Suitable for tightening and loosening KM, KML, N, AN, KMK, KMFE and KMT lock nuts, facilitating the use in a wide range of housing and shaft applications
- The large contact area of the spanner around the nut provides excellent grip and force transmission
- Exact fit reduces the risk of shaft, nut and housing damage
- Designation is laser-engraved on the handle allowing easy identification and selection
- Additional five larger sizes for nut outer diameter 155 to 210 mm (6.1 to 8.3 in) are available upon request
- Hole in the spanner's handle facilitates easy storage

### Impact spanners TMFN series

#### High impact forces without nut damage

SKF impact spanners are designed for safe and easy tightening and loosening of locknuts used to secure and adjust larger bearings directly on the shaft or with adapter and withdrawal sleeves.

- Avoids shaft and nut damage
- Safe and user friendly
- Impact applied effectively to the nut
- Suitable for nuts of series KM, KML, HM..T, HML..T, HM 30, HM 31, AN.., N.. and N... (for nut sizes 23 and above)
- Special wide impact face

115



## Axial lock nut sockets TMFS series

### Easy mounting and dismounting without nut damage

SKF axial lock nut sockets are designed for safe and easy tightening and loosening of lock nuts. They are used to

- Demands less space around the bearing arrangement than hook spanners
- Inch connections for power tools or torque wrenches
- TMFS fits nuts of series KM, KMK (metric) and KMF

secure and adjust bearings on tapered journals, adapter sleeves and withdrawal sleeves.

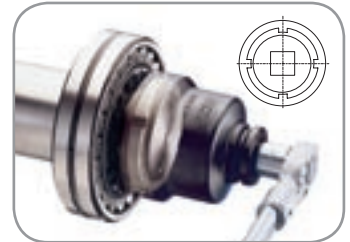

## Bearing handling tool TMMH series

### Get a safe grip on handling bearings

The SKF bearing handling tool is a simple, yet ingenious solution to problems associated with handling medium and large size bearings, weighing up to 500 kg (1 100 lb). The Bearing Handling Tool consists of a steel band with two handles and two anti-rotation plates, which fits around the outer ring of the bearing whilst the bearing is still in horizontal position.

By turning the two handles, the bearing handling tool is tightly fitted around the bearing. The two anti-rotation plates fix the inner ring and the rolling elements, preventing them from swivelling. This combination, the bearing and the bearing handling tool, can then be lifted manually or by a crane and turned to the vertical position safely, easily and quickly.

### Bearing handling has never been safer, easier or quicker

- A** Place the bearing handling tool around the bearing while it is still in horizontal position.
- One tool suitable for many bearing types and sizes
  - Tightly fits around the outer ring
  - The two anti-rotation plates fix the inner ring and the rolling elements, preventing them from swivelling during lifting
- B** Lift the combination, bearing and Bearing handling tool, using a crane.
- The bearing can be lifted from its horizontal position, safely and easily
  - The tightly secured bearing is prevented from falling, minimising injury to the operator or damage to itself
  - Full surface contact during lifting prevents damage to the bearing, which can be caused by one-point grip or lifting hooks

- C** Turn the combination to vertical position for placement on the shaft.
- Fixing the inner ring allows easy placement on the shaft and helps preventing damage to the ring or the rolling elements
  - Easy and simple, one operator can complete the job
- D** The bearing is placed on the shaft during mounting.
- The job is safely, easily and quickly done
  - Time-savings compared to conventional handling methods can be more than 50%

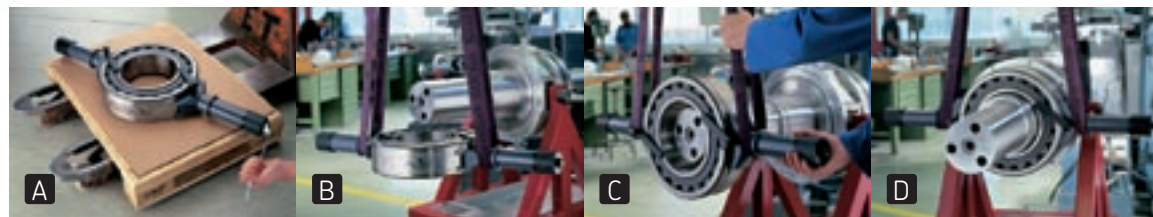





## Mounting bearings using heat

The force needed to mount a bearing increases rapidly with bearing size. Because of the mounting force required, larger bearings cannot easily be pressed onto a shaft or into a housing. Therefore the bearing or the housing is heated before mounting.

### Principle of induction heating

An induction heater can be compared to a transformer using the principle of a primary coil with a large number of windings, and a secondary coil with a few windings, on a mutual iron core. The input/output voltage ratio is equal to the ratio of the windings, while the energy remains the same. Consequently, the secondary coil will provide a low voltage at a high amperage. In the case of the SKF induction heater, the bearing is a short circuited, single turn, secondary coil through which a low A.C. voltage flows at high amperage, thus generating high heat. The heater itself, as well as the yoke, remains at ambient temperature. As this type of heating induces an electric current, the bearing will become magnetised.

It is important to ensure that the bearing is then demagnetised so that it will not attract metal particles during operation. All SKF induction heaters have automatic demagnetising cycles.

### Hot mounting

The temperature difference between the bearing and seating depends on the magnitude of the interference fit and the bearing size. Normally a bearing temperature of 80 to 90 °C (144 to 162 °F) above that of the shaft is sufficient for mounting. Never heat a bearing to a temperature greater than 125 °C (257 °F), because the material may change metallurgically and produce alterations in diameter or hardness. Local overheating must be avoided and in particular never heat a bearing using an open flame.

Wear clean protective gloves when mounting a hot bearing. Lifting (hoisting) gear can facilitate mounting. Push the bearing along the shaft as far as the abutment and hold the bearing in position, pressing until a tight fit is obtained. SKF supplies a full range of heating tools, such as induction heaters and electric hot plates with an adjustable thermostat and cover for all common mounting needs.

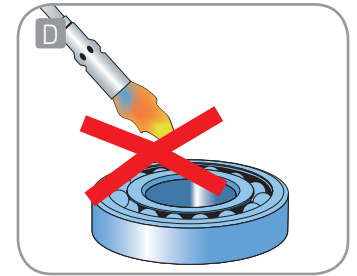
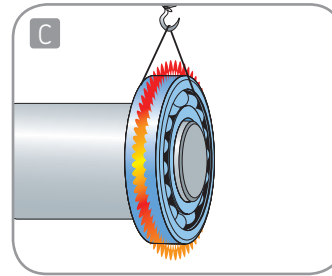
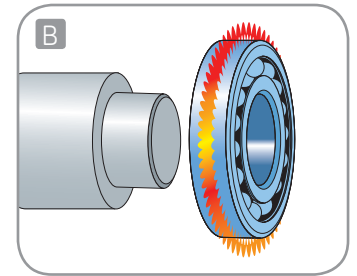
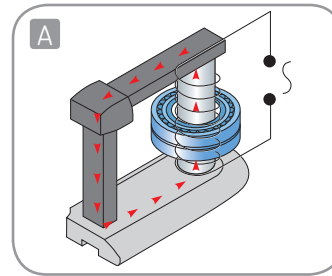

A Principle of induction heating

B Hot mounting

C Lifting gear

D Never heat a bearing using an open flame

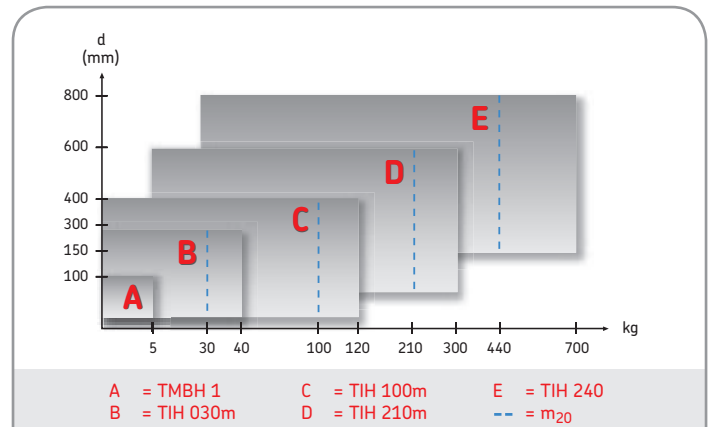

### Selection guide

There are no totally restrictive guidelines to follow when choosing your SKF bearing heater. It will depend upon the type and geometrical dimensions of the components you want to heat. Nevertheless, SKF offers the following helpful general selection guide.

### SKF m<sub>20</sub> concept

"m<sub>20</sub>" represents the weight (kg) of the heaviest SRB 231 bearing which can be heated from 20 to 110 °C (68 to 230 °F) in 20 minutes. This defines the heater's power output instead of its power consumption.

## SCORPIO induction heater TMBH 1

### A portable bearing heater weighing only 4,5 kg (10 lb)

The SKF bearing heater TMBH 1 is a portable lightweight heater for heating bearings with an inner diameter ranging from 20 to 100 mm (0.8 to 4 in) and a maximum corresponding weight of 4,5 kg (10 lb). The heater uses a patented method of heating based on high frequency induction, which provides optimised efficiency.

- Lightweight and portable (4,5 kg – 10 lbs)
- Heating efficiency better than 85%
- Components are not magnetised
- Equipped with temperature and time control
- Supplied with a heating clamp, temperature probe, power cable, heat resistant gloves and a carrying case

116



## Electric hot plate 729659 C

### Thermostat controlled bearing heating

The SKF electric hot plate, 729659 C, is a professional heating device especially designed for pre-heating small bearings prior to mounting. The temperature of the plate can be adjusted at the turn of a knob to provide a temperature range of between 50 and 200 °C (120 and 390 °F).

- Adjustable temperature range of 50 – 200 °C (120 – 390 °F)
- Protective cover to avoid contamination during heating

117





## Portable Induction Heater TIH 030m

Small bearing heater with high heating capacity of up to 40 kg bearing

The new SKF small induction heater TIH 030m combines high heating capacity with portability. The compact lightweight design makes the TIH 030m portable. Placing the induction coil outside the heater's housing allows the heating of bearings weighing up to 40 kg (88 lb). The heater is equipped with thermal overheating protection to reduce the risk of damage to the induction coil and the electronics.

In addition to temperature mode, the TIH 030m is equipped with a time mode for heating components other than bearings. The heater is supplied standard with three yokes and is available in two executions: 230V/50–60Hz and 100–110V/50–60Hz.

### SKF m<sub>20</sub> concept

"m<sub>20</sub>" represents the weight (kg) of the heaviest SRB 231 bearing which can be heated from 20 to 110 °C (68 to 230 °F) in 20 minutes. This defines the heater's power output instead of its power consumption.

- Compact lightweight design; just 20,9 kg (46,0 lb) facilitating portability
- 2-step power setting and smaller yokes allow heating smaller bearings safely and at lower power consumption
- Capable of heating a 28 kg (61,7 lb) bearing in just 20 minutes
- Temperature mode pre-set at 110 °C (230 °F) to help prevent bearing over-heating
- Automatic demagnetisation
- 3 years warranty

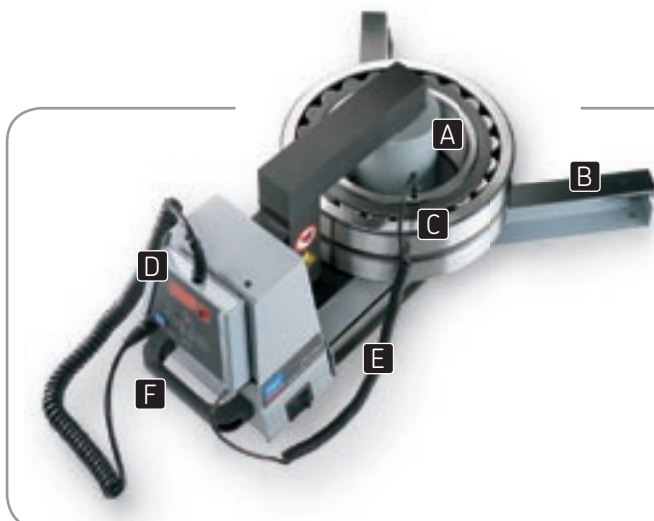

- A** Induction coil outside the heater's housing allows shorter heating time and lower energy consumption
- B** Foldable bearing support arms facilitate the heating of larger diameter bearings
- C** Magnetic temperature probe helps prevent bearing overheating
- D** Easy-to-use control panel and LED display integrated in a remote control
- E** Internal storage for all 3 yokes reduces the risk of yoke damage or loss
- F** Integrated carrying handle facilitates portability

# Induction heater TIH 100m

Medium bearing heater with high heating capacity of up to 120 kg bearing



The SKF medium induction heater TIH 100m has the same high standards of efficiency and performance as the small heater combined with increased capacity. The advanced design of the power electronics allows features of accurate electric current control, cut-outs to avoid overheating, controls on rate of temperature increase, these are as some of the standard features in the TIH...m range.

In addition to temperature mode, the TIH 100m is equipped with a time mode for heating components other than bearings. The heater is supplied standard with three yokes and is available in two executions: 230V/50-60Hz or 400-460V/50-60Hz.

Placing the induction coil outside the heater's housing allows the heating of bearings weighing up to 120 kg (264 lb). The heater is equipped with thermal overheating protection to reduce the risk of damage to the induction coil and the electronics.

- Standard swivel arm for large size yoke
- Capable of heating a 97 kg (213 lb) bearing in less than 20 minutes, saving time and energy
- 2-step power setting and smaller yokes allow heating smaller bearings safely and at lower power consumption
- Temperature mode pre-set at 110 °C (230 °F) to help prevent bearing over-heating
- Automatic demagnetisation
- 3 years warranty

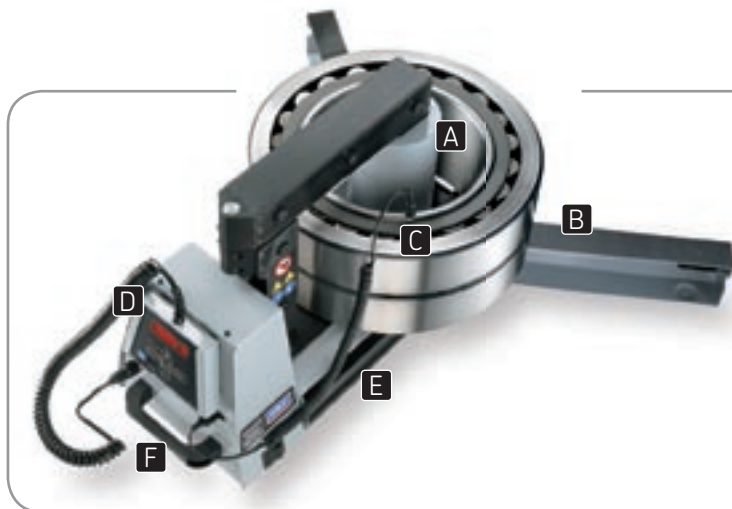

- A** Induction coil outside the heater's housing allows shorter heating time and lower energy consumption
- B** Foldable bearing support arms facilitate the heating of larger diameter bearings
- C** Magnetic temperature probe helps prevent bearing overheating
- D** Easy-to-use control panel and LED display integrated in a remote control
- E** Internal storage for all 3 yokes reduces the risk of yoke damage or loss
- F** Integrated carrying handle facilitates portability



## Mounting and lubrication



### Large induction heater TIH 210m

#### Heating a 210 kg bearing now takes as long as a coffee break

The SKF TIH 210m heats a 210 kg (460 lb) bearing from 20 to 110 °C (68 to 230 °F) in just 20 minutes. This incredible speed is achieved by positioning the induction coil outside the heater's housing, allowing the bearing to be placed around the coil.

This significant innovation results in reducing heating time and power consumption by up to 30%, ultimately saving up to 50% on heating costs.

- Thermal overheating protection of the induction coil and electronics
- Time and temperature modes for heating components other than bearings
- Automatic demagnetisation
- One power supply execution ranging from 400V/50Hz to 460V/60Hz, the SKF TIH 210m detects the power supply and automatically adjusts its voltage accordingly
- Compact design

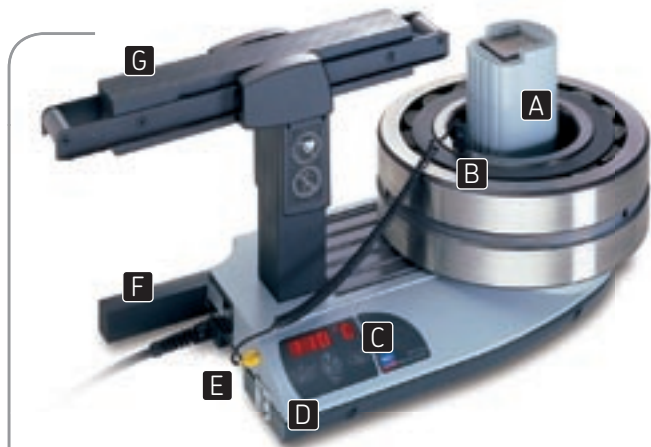

- A** Induction coil outside the heater's housing heats a 210 kilogram bearing in just 20 minutes. Reduces heating time and energy consumption by 30%. Reduces heating cost by 50%
- B** Magnetic temperature probe monitors bearing temperature during heating
- C** Easy-to-use control panel with LED display and temperature mode pre-set at 110 °C (230 °F), helps preventing bearing overheating
- D** 4-step power reduction heats smaller bearings just as quickly but at lower power consumption
- E** Integrated carrying handles provide excellent grip when moving the TIH 210m around
- F** Internal yoke storage for the second yoke reduces the risk of yoke damage or loss
- G** Sliding arm allows easy and quick bearing placement

## Induction heater trolley TIH T1

Move induction heaters from one job to another easily and quickly

118

The SKF TIH T1 trolley is designed to improve mobility when using SKF induction heaters, especially the larger ones. The trolley has a high carrying capacity of up to 900 kg (1 934 lb) and is fitted with a drawer with an oil resistant mat and two adjustable dividers.



## Special heaters for large components

Custom-made to your specifications

SKF can quote for the supply of special heaters for large heating jobs. To provide an accurate quotation the following information is required:

- Dimensions of the component to be heated ( $d \times D \times H$ )
- Weight in kg or lb
- Required heating temperature
- Desired heating times
- Available power supply
- Demagnetisation requirements
- Temperature or time control requirements
- Portability requirements, if any
- A sketch or drawing of the component to be heated

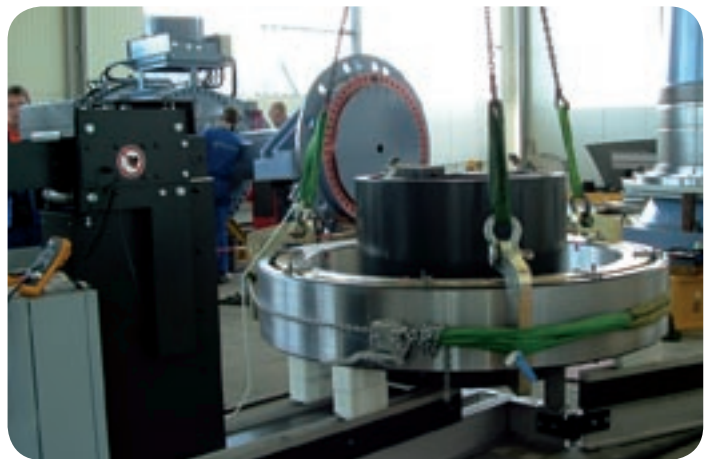
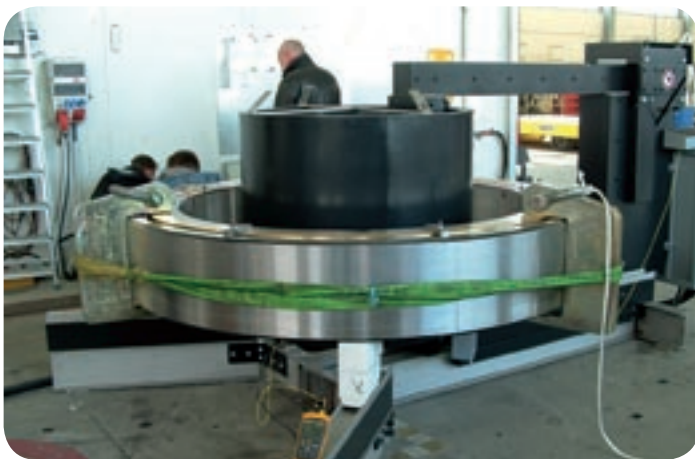
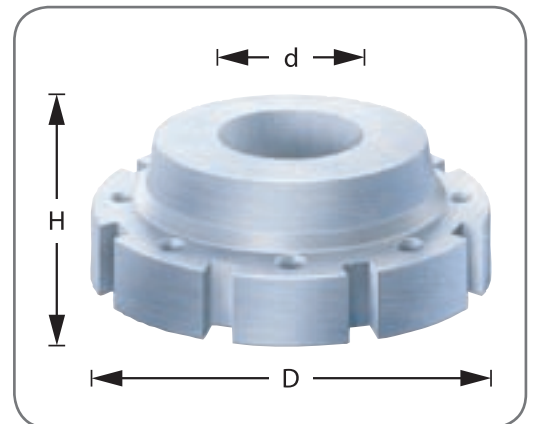

SKF also offers a range of heating equipment, which can be used for both mounting and dismantling bearings. The range includes aluminium rings, TMBR series, as well as fixed and adjustable EAZ induction heaters. For details of these products, please see pages 106 – 107 of this catalogue.



# Mounting bearings using hydraulic techniques

## SKF pioneered hydraulic mounting techniques

SKF invented hydraulic techniques for mounting bearings in the 1940 s. Since then, the SKF hydraulic methods have been further developed to become the preferred mounting methods for larger bearings as well as other components. These techniques have helped to simplify bearing arrangements and facilitate correct and easy mounting.

With the SKF hydraulic mounting techniques you can achieve:

- More control, allowing precision, accuracy and repeatability to be maintained
- Minimum risk of damaging the bearings and shafts
- Less manual effort
- Greater operator safety

## The SKF Oil Injection Method

### Makes bearing mounting an easy task

The SKF Oil Injection Method allows bearings and other components with an interference fit to be fitted in a safe, controllable and rapid manner. The method does not require keyways to be machined on the shaft, saving valuable time and money in materials and production. Interference fits (also known as shrink fits) have long been recognised for their reliability in transmitting large torsional loads. Very often interference fits offer the only solution when connecting hubs to shafts with intermittent or fluctuating loads.

The SKF Oil Injection Method is used to mount bearings on tapered seatings in combination with a hydraulic nut. The method, which is used for many bearing applications, can also be found in other applications, such as:

- Couplings
- Gear wheels
- Railway wheels
- Propellers
- Built-up crankshafts



## Tapered shafts

### The concept

**A** Injecting oil between two tapered surfaces creates a thin oil film, which reduces the friction between them, thereby significantly reducing the mounting force required. The thin oil film also minimises the risk of metallic contact when mounting, reducing the risk of component damage.

### The preparation

**B** During manufacture the shafts are prepared with oil ducts and grooves. For technical information on how to prepare the shafts, consult an SKF application engineer.

### The action

**C** Bearings are mounted by pushing them up the shaft with the aid of an SKF HMV .. E nut.

**D** The force to mount the bearing is reduced if oil is injected between the shaft and the bearing. This is often done with larger size bearings.

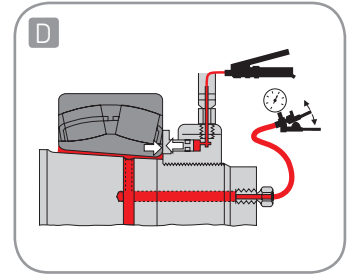
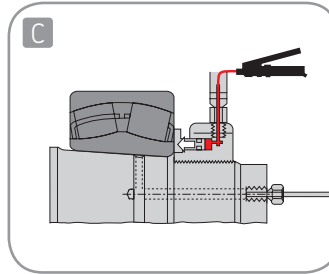
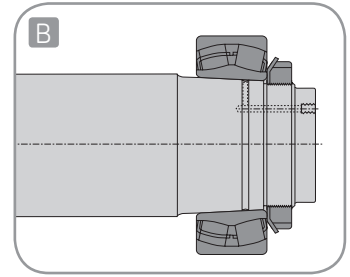
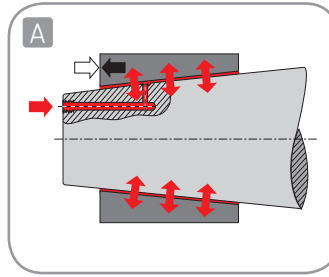

In addition to mounting bearings on tapered seatings, the SKF Oil Injection Method can be also used for dismantling bearings mounted on either tapered or cylindrical seatings. See page 108 of this catalogue for more details.

## SKF Oil Injection Method CD-ROM

### The SKF oil injection calculations made easy

The CD-ROM calculation program computes easily the laborious manual calculations often necessary for the SKF Oil Injection Method. Additionally, the CD-ROM provides theoretical details behind the method plus information on designing components, practical experiences, application examples and more. The CD-ROM provides you with detailed instructions and practical information on how to use the SKF Oil Injection

Method for mounting and dismantling bearings, as well as using the method in design, calculation and application of shrink fitted components. In addition, the program includes animations, photographs, detailed product information and instructions for use, as well as video clips showing various methods and techniques.

### The CD-ROM is a powerful tool, which includes the following features:

- User-friendly calculation program to determine pressures, stresses and interference levels
- Explanations of the theoretical background
- Information on designing components
- Information on SKF products, which enable the Oil Injection Method to be used
- Practical experiences and application examples
- Complete SKF Drive-up Method program for fitting spherical roller bearings and CARB® bearings in a safe, rapid and controlled manner
- Information on related SKF products such as gauges, heaters and pullers

### The benefits of using the SKF Oil Injection Method CD-ROM include:

- Substantial time and cost-savings
- Elimination of arithmetic errors
- Ability to see the effects of design changes in seconds
- All information on Oil Injection gathered on one CD-ROM
- Quick and easy access to all the advantages of the Oil Injection Method







## The SKF Drive-up Method

### Accurate axial drive-up of spherical roller and CARB® bearings



The SKF Drive-up Method is a well-proven method of accurately achieving the adjustment of spherical roller and CARB® bearings, mounted on tapered seatings, which is unique to SKF. The correct fit is achieved by controlling the axial drive-up of the bearing from a predetermined position. The method incorporates the use of an SKF HMV ..E hydraulic nut fitted with a dial indicator, and a high accuracy digital pressure gauge, mounted on the selected pump.

- Reduces the use of feeler gauges
- Greatly reduces the time to mount spherical roller and CARB® bearings
- A reliable and accurate method of adjustment
- The only suitable way to mount sealed spherical roller and CARB® bearings

Special hydraulic pressure tables have been developed, providing the required pressures, for each bearing type. This enables accurate positioning of the bearing at the starting point from where the axial drive-up is measured.



#### Step by step procedure

1. Ensure that the bearing size is equal to the HMV ..E-nut. (Otherwise the pressure in the table must be adjusted.)
2. Determine whether one or two surfaces slide during mounting; see figures A–D.
3. Lightly oil all mating surfaces with a thin oil, e.g. SKF LHM 300, and carefully place the bearing on the shaft.
4. Drive the bearing up to the starting position by applying the HMV ..E-nut pressure found in the table. Monitor the pressure by the gauge on the selected pump. SKF hydraulic pump 729124 SRB is suitable for hydraulic nuts  $\leq$  HMV 54E. SKF TMJL 100SRB is suitable for hydraulic nuts  $\leq$  HMV 92E while TMJL 50SRB is suitable for nuts  $\leq$  HMV 200E. As an alternative the SKF digital pressure gauge TMJG 100D can be screwed directly into the hydraulic nut.

5. Drive the bearing up the taper by the required distance  $S_s$ . The axial drive-up is best monitored by a dial indicator. The SKF hydraulic nut HMV ..E is prepared for dial indicators. Normally, the bearing is now mounted with a suitable interference on the shaft and a suitable residual clearance.

*For abnormal operating conditions, hollow shafts, very accurate requirements on residual clearance etc., the drive-up must be adjusted. In such cases please contact SKF or refer to the SKF Drive-up Method CD-ROM or [skf.com/mount](http://skf.com/mount).*

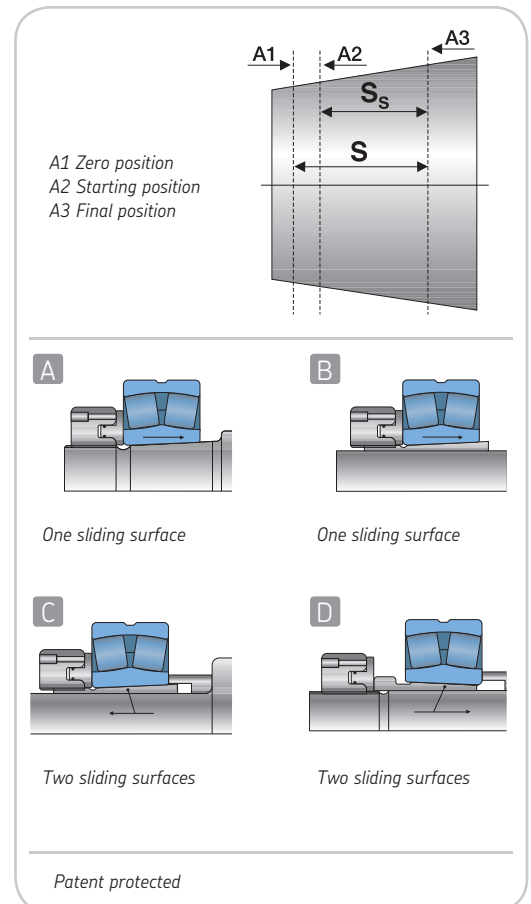

## Hydraulic nut drive-up adapter HMVA 42/200

For use with previous generation of SKF HMV(C) hydraulic nuts

The SKF Drive-up Method is the preferred method for mounting SKF spherical roller and CARB® bearings on tapered seatings. In conjunction with an SKF dial indicator, the adapter allows the previous generation of HMV nuts to be used with the SKF Drive-up Method.

- One adapter suits previous generation nuts from HMV(C) 42 up to 200
- Rugged construction
- Easy to attach to the HMV nut using strong magnets
- Used in conjunction with SKF dial indicators

The adapter can be used with nuts from size HMV(C) 42 to HMV(C) 200. The adapter is not required for the current generation of HMV(C) ..E nuts.



## SKF Drive-up Method CD-ROM

A computerised handbook on mounting bearings with a tapered bore

The SKF Drive-up Method is used for mounting bearings with a tapered bore. This CD-ROM gives a description of the method with the aid of pictures, animations and tables. The program includes calculation modules covering most bearing mounting situations in seven languages.

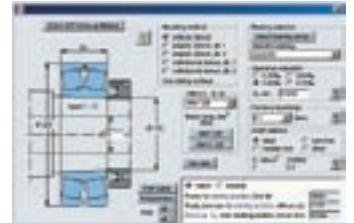

## Adapter and withdrawal sleeves for oil injection

Mounting bearings made easy

These SKF sleeves facilitate the use of the SKF Oil Injection Method. The larger sleeves have oil supply ducts and distribution grooves, enabling the user to inject oil between the sleeve and bearing bore and between the sleeve and the shaft. This oil reduces friction and force necessary for mounting, particularly when mounting in a dry state.

- Reduces the risk of damage to shaft and sleeve
- Reduces time to mount and dismount bearings
- A full range of pumps, nipples and pipes are available
- SKF sleeves also help making bearing dismounting easier

*For more information, please refer to the SKF General Catalogue, the SKF Maintenance Handbook or consult an SKF application engineer.*

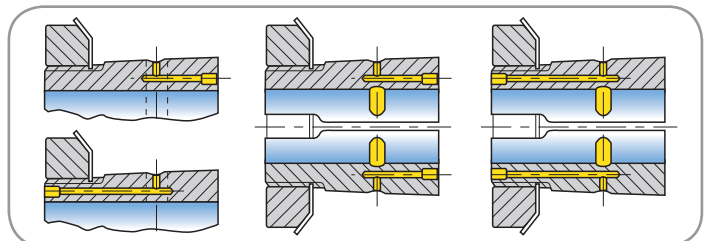



# Mounting and lubrication

## Hydraulic nuts HMV ..E series

### Easy application of high drive-up forces

Mounting bearings on tapered seatings can be a difficult and time-consuming job. Using an SKF hydraulic nut facilitates easy and quick application of the high drive-up forces required for mounting bearings.

- Wide size range, covering shaft diameters from 50 to 1 000 mm as standard
- Full range of inch threads available, series HMVC ..E - 1,967 up to 37,410 in
- Quick connection coupling can be fitted on the face or side of the nut, allowing the nut to be used in areas where space is limited
- Spare set of piston seals and Maintenance kit supplied as standard
- To assist nut threading, a tube of lubricant is supplied standard with all nuts from size HMV(C) 54E
- To facilitate easy nut threading, all nuts from size HMV(C) 54E are equipped with two tommy bars and four mating holes on their front face
- Nuts from size HMV(C) 94E are equipped with eyebolts, allowing easy handling
- Nuts from size HMV(C) 94E have the starting position of the thread indicated, facilitating easy matching of thread positions on both the nut and mating thread
- Special threads and sizes available on request

All HMV ..E nuts are equipped with a quick connection coupling to fit the SKF hydraulic pumps.



In addition to facilitating the mounting of bearings, SKF hydraulic nuts HMV E series can be also used to assist during dismantling them. See page 109 of this catalogue for more details.

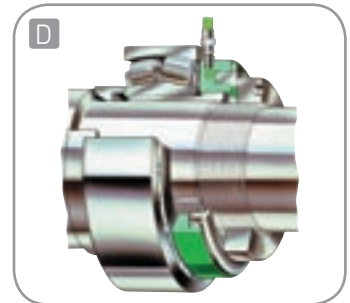
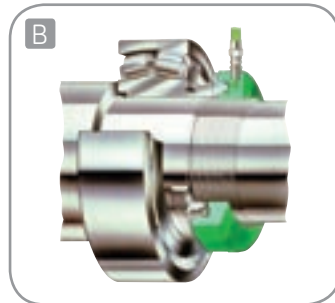
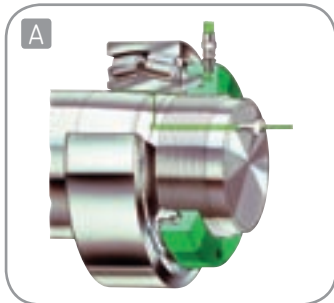

- A** HMV ..E nut for driving the bearing onto a tapered seating.
- B** HMV ..E nut screwed onto the shaft for driving in a withdrawal sleeve.

- C** HMV ..E nut for driving the bearing onto an adapter sleeve.
- D** HMV ..E nut and special stop nut for driving in a withdrawal sleeve.

## Feeler gauges 729865 series

### For accurate bearing clearance measurement

SKF feeler gauges are designed to measure the internal clearance when adjusting spherical roller bearings. Two types are available, one with 13 blades of 100 mm (4 in) length and the other with 29 blades of 200 mm (8 in) length.

- High accuracy of measurement
- 729865 A is supplied with protective plastic cover
- 729865 B is supplied with protective steel cage

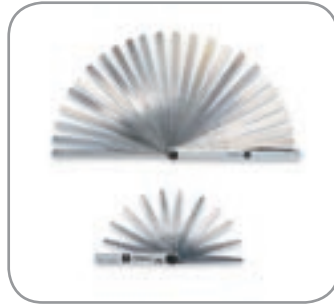

121

## SensorMount® indicator TMEM 1500

### The tool to monitor the mounting of SensorMount® bearings

The SensorMount® Indicator TMEM 1500 provides a direct reading of the fit of a “SensorMount®” bearing mounted on a tapered seating. The SensorMount® Indicator is only compatible with SKF bearings, which are fitted with the SensorMount® sensor. These bearings from SKF have the designation suffixes ZE, ZEB, or ZEV, e.g. ZE 241/500 ECAK30/W33.

**What you see is what you get; directly indicates the real reduction in internal bearing clearance**

- Easy to use
- Fast
- Reliable
- Simplifies the mounting process:
  - No calculations needed
  - Makes feeler gauges obsolete
  - Minimises the risk of human errors

The SensorMount® Indicator provides a numeric value, which guides the user in achieving a reliable bearing fit. SKF bearings fitted with the SensorMount® system can also be mounted on adapter sleeves, withdrawal sleeves and hollow shafts. The material composition of the shaft has no effect on the proper operation of the SensorMount® system.



*Note: SensorMount® is a registered trademark of the SKF Group*

120



# Mounting and lubrication

## Hydraulic pumps and oil injectors selection guide

Max. working pressure	Pump	Type	Oil container capacity	Connection nipple	Mounting Applications*
30 MPa 4 350 psi	<b>THAP 030</b>	Air-driven pump	Separate container oil	G 3/4	OK couplings
50 MPa 7 250 psi	<b>TMJL 50</b>	Hand operated pump	2 700 cm <sup>3</sup> (165 in <sup>3</sup> )	G 1/4	≥ HMV 92E OK couplings
100 MPa 14 500 psi	<b>729124</b>	Hand operated pump	250 cm <sup>3</sup> (15 in <sup>3</sup> )	G 1/4	≤ HMV 54E
	<b>TMJL 100</b>	Hand operated pump	800 cm <sup>3</sup> (48 in <sup>3</sup> )	G 1/4	≤ HMV 92E
150 MPa 21 750 psi	<b>THAP 150</b>	Air-driven pump	Separate container	G 3/4	Bolt tensioners, propeller mounting
	<b>728619 E</b>	Hand operated pump	2 550 cm <sup>3</sup> (155 in <sup>3</sup> )	G 1/4	All HMV ..E nuts
300 MPa 43 500 psi	<b>THAP 300E</b>	Air-driven pump	Separate container	G 3/4	OK couplings Large pressure joints
	<b>226400</b>	Hand operated oil injector	200 cm <sup>3</sup> (12,2 in <sup>3</sup> )	G 3/4	OK couplings Adapter / withdrawal sleeves
	<b>729101 B</b>	Oil injection kit	200 cm <sup>3</sup> (12,2 in <sup>3</sup> )	Several	Many applications, such as OK couplings Adapter / withdrawal sleeves
	<b>TMJE 300</b>	Oil injection set	200 cm <sup>3</sup> (12,2 in <sup>3</sup> )	Several	
	<b>226270</b>	Screw injector	5,5 cm <sup>3</sup> (0,33 in <sup>3</sup> )	G 3/8	Machine tool applications shaft diameter ≤ 100 mm
	<b>226271</b>	Screw injector	25 cm <sup>3</sup> (1,5 in <sup>3</sup> )	G 3/4	Machine tool applications shaft diameter ≤ 200 mm
400 MPa 58 000 psi	<b>226400/ 400 MPa</b>	Hand operated oil injector	200 cm <sup>3</sup> (12,2 in <sup>3</sup> )	G 3/4	Joints with high interference fits
	<b>729101 E</b>	Oil injection kit	200 cm <sup>3</sup> (12,2 in <sup>3</sup> )	G 1/4	Complete kit / set to suit many applications
	<b>TMJE 400</b>	Oil injection set	200 cm <sup>3</sup> (12,2 in <sup>3</sup> )	G 1/4	

\*The mounting applications given above are for guidance only. The interference fit present may mean that a pump / injector with a higher-pressure capacity is required.

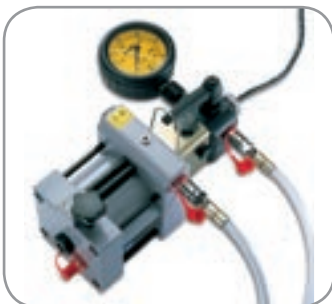

## Hydraulic pump 729124

### 100 MPa (14 500 psi)



The 729124 pump is suitable for use with hydraulic nuts ( $\leq$  HMV 54E) to mount bearings or components where a maximum pressure of 100 MPa (14 500 psi) is required. The pump is supplied with 1500 mm (59 in) pressure hose, quick connect coupling and mating nipple and pressure gauge.

- Suitable for hydraulic nuts  $\leq$  HMV 54E
- Extra litre of mounting fluid
- Special pump configurations available
- Packed in a sturdy protective case
- Oil container capacity 250 cm<sup>3</sup> (15 in<sup>3</sup>)

#### Applications

- SKF hydraulic nuts  $\leq$  HMV 54E
- All other oil injection applications where the maximum pressure is 100 MPa (14 500 psi)

The pump is filled with SKF mounting fluid LHM 300 and is supplied with an extra litre of fluid. For applications where space does not permit the use of a quick connect coupling and nipple, such as AOH sleeves, a special pump design is available (729124 A).



## Hydraulic pump TMJL 100

### Large oil container 100 MPa (14 500 psi)



The TMJL 100 pump is suitable for use with hydraulic nuts ( $\leq$  HMV 92E) to mount bearings or components where a maximum pressure of 100 MPa (14 500 psi) is required. The pump is supplied with 3000 mm (118 in) pressure hose,

- Suitable for hydraulic nuts  $\leq$  HMV 92E
- Suitable with SKF hydraulic assisted pullers TMHP series
- Extra litre of mounting fluid
- Packed in a sturdy protective case
- Oil container capacity 800 cm<sup>3</sup> (48 in<sup>3</sup>)

#### Applications

- SKF hydraulic nuts  $\leq$  HMV 92E
- All other oil injection applications where the maximum pressure is 100 MPa (14 500 psi)
- SKF hydraulic assisted pullers TMHP series

quick connect coupling and mating nipple, and pressure gauge. The pump is filled with SKF mounting fluid LHM 300 and is supplied with an extra litre of fluid.





## Mounting and lubrication

### Hydraulic pump TMJL 50

50 MPa (7 250 psi)



The TMJL 50 pump is mainly intended for use on the low-pressure side of SKF OK couplings, but is also suitable for applications where a maximum pressure of 50 MPa (7 250 psi) is required. The pump is supplied with a 3 000 mm (118 in) long high-pressure hose with quick connect coupling

- Large oil container (cap. 2 700 cm<sup>3</sup>, 165 in<sup>3</sup>)
- Over pressure valve
- Extra litre of mounting fluid
- Packed in a sturdy protective case

#### Applications

- Low pressure side of SKF OK couplings
- Larger size hydraulic nuts (≥ HMV 94E)
- All other oil injection applications where the maximum pressure is 50 MPa (7 250 psi)

and mating nipple. It is filled with SKF mounting fluid LHMf 300 and is supplied with an extra litre of fluid. The pump is fitted with an over-pressure valve and has a connection port for a pressure gauge.



### Hydraulic pump 728619 E

150 MPa (21 750 psi)



The 728619 E is a two-stage pump suitable for use with SKF Supergrip bolts and to mount bearings or components where a maximum pressure of 150 MPa (21 750 psi) is required. The pump is supplied with a 3 000 mm (118 in) pressure hose, quick connect coupling and mating nipple and pressure gauge.

- Two stage pressure pumping
- Extra litre of mounting fluid
- Packed in a sturdy protective metal case
- Oil container capacity 2 550 cm<sup>3</sup> (155 in<sup>3</sup>)

#### Applications

- SKF Supergrip bolts
- All other oil injection applications where the maximum pressure is 150 MPa (21 750 psi)
- All sizes HMV ..E hydraulic nuts

The pump is filled with SKF mounting fluid LHMf 300, is supplied with an extra litre and is protected in a sturdy metal case.



## Air-driven hydraulic pumps, THAP series

30, 150, 300 and 400 MPa (4 350, 21 750, 43 500 and 58 000 psi)



The THAP air-driven pumps are available in four different pressure versions. They can be used for mounting OK couplings, large pressure joints such as bearings, flywheels, couplings and railway wheels. The pumps consist of a high-pressure hydraulic pump, driven by an air piston.

The units are supplied in a sturdy case including oil suction and return hoses with quick connect couplings. The pumps can also be supplied in complete sets, which consists of pump, pressure gauge, adapter block, high-pressure pipe and connection nipples.

- Time savings compared to hand operated pumps
- Portable
- Continuous supply of oil
- Sturdy storage boxes
- Low, medium and high pressure units

### Applications

- SKF OK-Couplings
- Mounting bearings
- Mounting ship propellers, rudder pintles, railway wheels and other similar applications

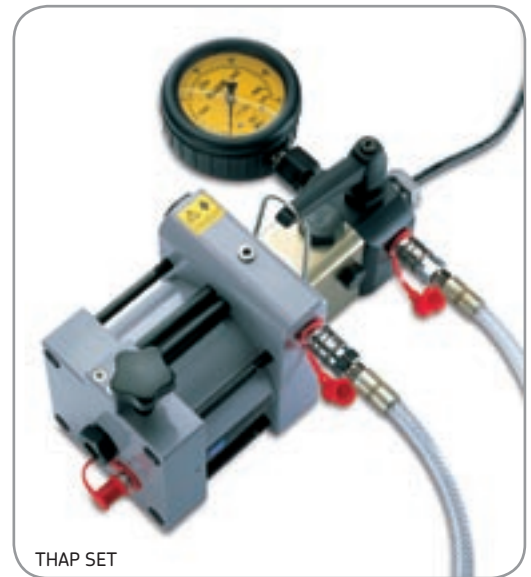

## Screw injectors 226270 and 226271

300 MPa (43 500 psi)

The 226270 and 226271 screw injectors are mainly used within the machine tool industry for mounting bearings and components using the SKF Oil Injection Method. Valve nipples 226272 and 226273 can be used to retain the oil pressure while the injector is refilled.



### 226270

- Suitable for components with a shaft diameter up to 100 mm (4 in)
- Oil container capacity 5,5 cm<sup>3</sup> (0,33 in<sup>3</sup>)

### 226271

- Suitable for components with a shaft diameter not exceeding 200 mm (8 in)
- Oil container capacity 25 cm<sup>3</sup> (1,5 in<sup>3</sup>)







## Mounting and lubrication

### Oil injector 226400 series

300 and 400 MPa (43 500 and 58 000 psi)

The 226400 series oil injectors have a varied usage when applying the SKF Oil Injection Method. For mounting bearings, couplings, railway wheels, gear wheels, flywheels, ship propellers and so on. The injector is supplied with an oil reservoir in a compact carrying case.

- Easy to operate
- Compact carrying case
- Large range of accessories available, including:
  - Adapter block
  - Pressure gauges
  - High pressure pipes
  - Connecting nipples
- Oil container capacity 200 cm<sup>3</sup> (12,2 in<sup>3</sup>)

#### Applications

- For mounting and dismantling of:
  - Bearings
  - Couplings
  - Railway wheels
  - Gear wheels
  - Flywheels
  - Ship propellers and so on
- For any oil injection application where maximum pressure of up to 400 MPa (58 000 psi) is required

For applications where 400 MPa (58 000 psi) is required a special model is available: 226400/400 MPa. The injector can be mounted directly onto the work piece or connected to an adapter block to make it a floor standing model making it easy to connect pressure gauges and high-pressure pipes.



### Oil injection kits 729101 series

300 and 400 MPa (43 500 and 58 000 psi)

The oil injection kits contain the oil injector 226400 complete with high pressure pipe, pressure gauge, adapter block and a range of connection nipples all packed together in a sturdy plastic carrying case.

- Complete high-pressure kits, including oil injector, pressure gauge, 2,0 m high-pressure pipe and a range of connection nipples
- Oil container capacity 200 cm<sup>3</sup> (12,2 in<sup>3</sup>)



#### Ordering details

Designation	Description
729101 B	Oil injection kit (300 MPa / 43 500 psi)
729101 E	Oil injection kit (400 MPa / 58 000 psi)

#### Contents list

Designation	729101 B	729101 E
Oil injector	226400	226400/400 MPa
Adapter block	226402	226402
High pressure pipe (G 3/4 - 1/4)	227957 A	227957 A/400 MPa
Connection nipple (G 1/4 - 1/8)	1014357 A	-
Connection nipple (G 1/4 - 1/2)	1016402E	1016402E
Connection nipple (G 1/4 - 3/4)	228027E	228027E
Pressure gauge (0 - 300 MPa)	1077589	1077589/2 (0-400 MPa)
Carrying case	729111 B	729111 B

## Oil Injection sets TMJE 300 and 400 series

300 and 400 MPa (43 500 and 58 000 psi)

122

The SKF TMJE 300 and 400 are used for mounting of pressure joints of all sizes and applications such as propellers, rolling bearings, couplings, gears, pulleys, flywheels and SKF OK-couplings.

- Complete high-pressure set with integral pressure gauge, oil reservoir and 2,0 m high-pressure pipe
- Can be dismantled and used directly on the application
- Provided with range of connection nipples
- Oil container capacity 200 cm<sup>3</sup> (12,2 in<sup>3</sup>)



### Contents list

Designation	TMJE 300	TMJE 400
Oil injector	TMJE 300-1	TMJE 400-1
Pressure gauge	1077589	1077589/2
High pressure pipe (G 3/4 – 1/4)	227957 A	227957 A/400MPa
Connection nipple (G 1/4 – 1/8)	1014357 A	–
Connection nipple (G 1/4 – 1/2)	1016402E	1016402E
Connection nipple (G 1/4 – 3/4)	228027E	228027E
Carrying case	728245/3A	728245/3A
Plug	729944E	729944E
Mounting fluid	LHMF 300/1	LHMF 300/1

## Hydraulic accessories

### Adapter block 226402

The adapter block 226402 consists of a cast steel block to which a pressure gauge and high-pressure pipe can be connected. It comes with a floor support and a 90 degree connection nipple for the oil reservoir.

123





# Mounting and lubrication

## High-pressure pipes

### Maximum working pressure 300 MPa (43 500 psi)

The range of SKF high-pressure pipes covers most applications where there is a requirement to transfer oil at high pressure. They consist of a steel pipe with a steel ball fitted to both ends.

- Wide range of pipes
- All pipes are pressure tested to 100 MPa (14 500 psi) over recommended working pressure
- Special lengths (up to 4 m / 157 in) made on request
- 400 MPa versions available

#### Safety note:

For safety reasons, these high-pressure pipes have a maximum recommended service life. All SKF high pressure pipes are hard-marked with the year in which their recommended service life expires; e.g. RECOMMENDED SERVICE LIFE EXPIRES 2010.

Two swivelling connection nipples press these balls against the seating of the connecting hole and thus sealing against oil leakage.



## Pressures gauges

### 100 to 400 MPa (14 500 to 58 000 psi)

SKF pressure gauges are designed to fit SKF hydraulic pumps and oil injectors. The gauges are all liquid filled and/or equipped with a restriction screw in order to absorb any sudden pressure drop and prevent damage.

- Covers pressures of 100 to 400 MPa (14 500 to 58 000 psi)
- Protection against sudden pressure drops
- Safety glass and blow out discs on all gauges
- Stainless steel case
- Dual scales MPa/psi
- Easy to read, high visibility yellow gauge faces

Safety glass and blowout discs are standard for all gauges and all have dual scales (MPa/psi).



## Plugs for oil ducts and vent holes

### Up to 400 MPa (58 000 psi)

SKF plugs have been designed to seal off oil connections at a maximum pressure of 400 MPa (58 000 psi).



## Flexible high-pressure hoses

### Maximum working pressure up to 150 MPa (21 750 psi)

The SKF flexible pressure hoses are designed to be used together with the quick connect coupling 729831 A and nipple 729832 A on the range of SKF hydraulic pumps.

#### Safety note:

All flexible pressure hoses are subject to ageing and after a number of years the performance deteriorates. All SKF flexible pressure hoses are hard marked with the year in which their life expires, e.g. LIFE EXPIRES 2008.



## Quick connecting coupling and nipples

### For easy pressure hose connection

One coupling and two different nipples are available to connect SKF hydraulic pumps to the work piece. When nipples with other thread types are required, select an additional SKF nipple from the range to make the connection. Nipple 729832 A is supplied standard with all SKF HMV ..E hydraulic nuts.



## Connection nipples with metric and G pipe threads

### External to internal metric and G pipe threads

SKF provides a wide range of connecting nipples covering many different thread combinations and sizes. All nipples with an E suffix have a maximum working pressure of 400 MPa (58 000 psi). The remainder have a maximum working pressure of 300 MPa (43 500 psi).



## Connection nipples with NPT tapered threads

### Connection nipples with tapered threads (NPT) and pipe threads (G)

SKF can also supply a range of adapters for connecting NPT threads to G threads. All nipples have a maximum working pressure of 300 MPa (43 500 psi).

Nipples having a maximum working pressure of 400 MPa (58 000 psi) are available on request.



## Extension pipes with connecting nipples

### Catering for difficult connection applications



#### M4 extension pipe with connection nipple

Used to extend a high-pressure pipe with a G 1/4 nipple (e.g. 227957 A) when the connection hole has an M4 thread. The extension pipe and connection nipple should be ordered as separate items.

#### M6 extension pipe with connection nipple

Used to extend a high-pressure pipe with a G 1/4 nipple (e.g. 227957 A) when the connection hole has a M6 thread. The extension pipe and connection nipple should be ordered as separate items.

#### Valve nipple with extension pipe

This combination is intended to be used between an oil pressure joint and an oil injector (226271) when a thin wall thickness of the pressure joint prevents the connection of the injector directly to the joint. The valve nipple is used to retain the pressured oil while the injector is refilled. The extension pipe and connection nipple should be ordered as separate items.

#### Extension pipe

This unit is used for connection to components with a thin wall thickness, such as sleeves with oil injection preparations. It is normally used in combination with high-pressure pipes such as 227957 A.



## Mounting fluid LHM 300

### For easy and quick bearing mounting

The SKF mounting fluid LHM 300 is suitable for use with SKF hydraulic equipment, including hydraulic pumps, HMV ..E nuts and oil injection tools. The LHM 300 contains anti corrosives

which are non aggressive to seal materials such as nitrile rubber, perbunan, leather and chrome leather, PTFE, and so on.

#### Ordering details and technical data

Designation	LHM 300/pack size
Specific gravity	0,882
Flash point	200 °C (390 °F)
Pour point	-30 °C (-22 °F)
Viscosity at 20 °C (68 °F)	300 mm <sup>2</sup> /s
Viscosity at 40 °C (104 °F)	116 mm <sup>2</sup> /s
Viscosity at 100 °C (212 °F)	17,5 mm <sup>2</sup> /s
Viscosity index	160
Available pack size	1, 5, 205 litre



# OK Coupling mounting and dismounting kits

Specially prepared kits are made to simplify the process of mounting and dismounting SKF OK couplings.

## Ordering details and selection chart

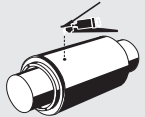
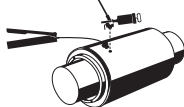
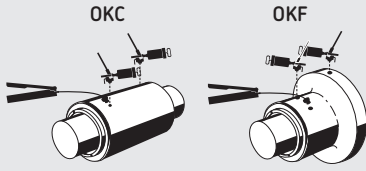
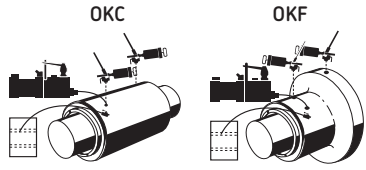
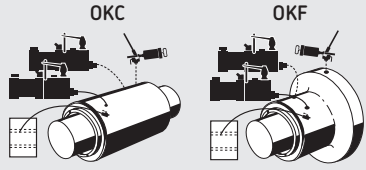
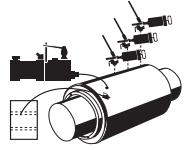
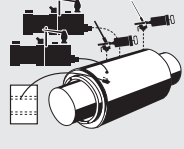
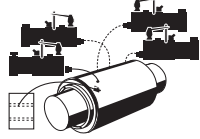
Coupling size	Designation	Contents	Weight	Application
OKC 25 – OKC 90	<b>TMHK 35</b>	1 × TMJE 300-1 Oil injector set 1 × 729944 E Plug 1 × 227958A Pressure pipe (for OKC 80 and 90) 1 × 729123A/2000 Pressure pipe (for OKC 25 – 75) Tools and storage case	13,8 kg (30,4 lb)	
OKC 100 – OKC 170 OKCS 178 – OKCS 360	<b>TMHK 36</b>	1 × 226400 Injector with spares 1 × TMJL 50 Hydraulic pump Tools and storage case	19 kg (41,8 lb)	
OKC 180 – OKC 250 OKF 100 – OKF 300 <i>* = for use with OKF couplings</i>	<b>TMHK 37</b>	2 × 226400 Injector with spares 1 × 226402 * Adapter block 1 × 227958A * High pressure pipe 1 × TMJL 50 Hydraulic pump Tools and storage case	28,1 kg (61,8 lb)	
OKC 180 – OKC 490 OKF 300 – OKF 700 <i>Shipboard or infrequent use</i>	<b>TMHK 38</b>	1 × THAP 030/SET Air-driven pump set 1 × 729147A Return hose 2 × 226400 Injector with spares	32,1 kg (70,6 lb)	
OKC 180 – OKC 490 OKF 300 – OKF 700 <i>Shipyard or frequent use</i>	<b>TMHK 38S</b>	1 × THAP 030/SET Air-driven pump set 1 × 729147A Return hose 1 × THAP 300E Air-driven pump 1 × 226400 Injector with spares	78,2 kg (172,3 lb)	
OKC 500 – OKC 600 <i>Shipboard or infrequent use</i>	<b>TMHK 39</b>	1 × THAP 030/SET Air-driven pump 1 × 729147A Return hose 3 × 226400 Injector with spares	35,1 kg (77,2 lb)	
OKC 500 and larger <i>Shipboard or infrequent use</i>	<b>TMHK 40</b>	1 × THAP 030/SET Air-driven pump 1 × THAP 300E Air-driven pump 1 × 729147A Return hose 2 × 226400 Injector with spares	80,2 kg (176,7 lb)	
OKC 500 and larger <i>Shipyard or frequent use</i>	<b>TMHK 41</b>	1 × THAP 030/SET Air-driven pump 3 × THAP 300E Air-driven pump 1 × 729147A Return hose	132,7 kg (293,3 lb)	



## Accessories

### SKF anti corrosive agent LHRP 1

SKF LHRP 1 provides excellent long-term corrosion protection to ferrous and non-ferrous metals. When applied, it leaves a stable rust protection film over the metal component.

- Excellent rust protection in high humidity environments (tests at 30 °C/80 °F – 90 % relative humidity indicates full protection for at least one year)
- Excellent long-term indoor storage protection



### Special working gloves TMBA G11W

For providing protection while maintaining excellent grip

The SKF working glove TMBA G11W are specially designed for general-purpose industrial maintenance work. The inside palm of the glove is coated with non-flammable dots providing excellent grip.

- Abrasion resistant
- Blade cut resistant
- Tear resistant
- Puncture resistant
- Flexible and comfortable gloves with excellent grip
- Lint free
- Tested and certified according to EN 388 (mechanical risks)



### Heat resistant gloves TMBA G11

For safe handling of heated components up to 150 °C (302 °F)

The SKF heat resistant gloves TMBA G11 are specially designed for the handling of heated bearings. They are made of special fabric to obtain the following combination of features:

- Lint free
- Heat resistant up to 150 °C (302 °F)
- Cut resistant
- Contains no asbestos
- Tested and certified for mechanical risks (EN 388) and thermal risks (EN 407)



## Extreme temperature gloves TMBA G11ET

For safe handling of heated components up to 500 °C (932 °F)

The TMBA G11ET gloves are especially designed for allowing the safe handling of heated bearings or other components for prolonged periods. They can withstand extreme temperatures of up to 500 °C (932 °F), without the presence of hot liquid or steam, with a high degree of non-flammability.

- Heat-resistance to extreme temperatures allows the safe and prolonged handling heated components
- High-degree of non-flammability reduces the risk of burning
- Extremely tough KEVLAR® gloves with high cut, abrasion, puncture and tear resistance for increased safety
- Lint-free design safeguards against bearing contamination
- Comfortable to wear, as they are knitted from flexible high performance materials in one piece without seams
- Tested and certified for mechanical risks (EN 388) and thermal risks (EN 407)



## Heat and oil resistant gloves TMBA G11H

For safe handling of oily and heated components up to 250 °C (482 °F)

The SKF heat and oil resistant gloves TMBA G11H are specially designed for the handling of hot and oily bearings. They are made of multiple layers of different kinds of fabric to obtain an important combination of features:

- A combination of heat, cut, oil and water resistance
- KEVLAR® gloves
- Melt and burn proof
- Maximum temperature: 250 °C (482 °F)
- Suitable for submerging in liquids of a temperature up to 120 °C (248°F) (e.g. hot oil bath)
- Remains heat resistant when wet
- Cut resistant
- Lint free
- Tested and certified for chanical risks (EN 388) and thermal risks (EN 407)







## Lubrication

### SKF greases for most bearing applications

Sealed bearings are pre-lubricated and do not require lubrication when mounted. However, in applications where open bearings are used, these bearings must be lubricated after mounting. Selecting the right bearing grease

for your application is another step to maximise your bearing's service life. SKF offers thirteen different bearing greases, which have been especially developed by SKF to cover most bearing applications.

#### SKF bearing greases

Designation	Description
LGMT 2	All purpose industrial and automotive bearing grease
LGMT 3	All purpose industrial and automotive bearing grease
LGEP 2	Extreme pressure bearing grease
LGLT 2	Low temperature, extremely high speed bearing grease
LGHP 2	High performance bearing grease
LGFP 2	Food compatible bearing grease
LGGB 2	Green biodegradable grease
LGWA 2	Wide temperature range bearing grease
LGHB 2	High viscosity, high temperature bearing grease
LGET 2	Extreme temperature bearing grease
LGEM 2	High viscosity bearing grease with solid lubricant
LGEV 2	Extremely high viscosity bearing grease with solid lubricant
LGWM 1	Extreme pressure low temperature bearing grease



For more information about the above listed SKF bearing greases, please see the Re-lubrication section of this catalogue on pages 49 – 76



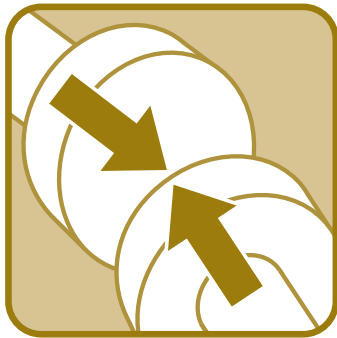

# Alignment

Misalignment costs time and money	42
Shaft alignment tools TMEA series	44
Thermal printer TMEA P1	46
Machinery shims TMAS series	46
Belt alignment tool BeltAlign TMEB 2	48



# Alignment



## Misalignment costs time and money

### Shaft misalignment

Shaft misalignment is responsible for up to 50% of all costs related to rotating machinery breakdowns. These breakdowns increase unplanned machinery downtime, resulting in higher maintenance costs and loss of production. Additionally, misaligned shafts can increase vibration levels and friction, which can significantly increase energy consumption and can cause premature bearing failures.

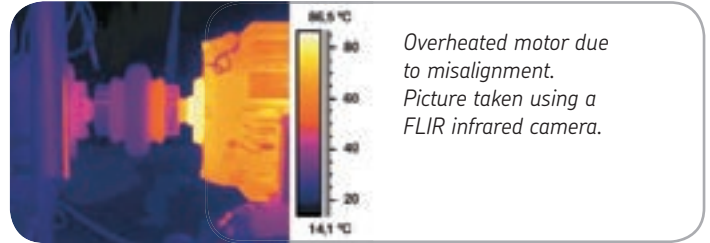

### Traditional shaft alignment methods

Traditional alignment methods, although very common, do not often produce the exacting degree of accuracy required by today's precision machinery. The rough alignment methods still used nowadays, such as using a straight edge and feeler gauge, may be quick, but they can be inaccurate.

Another traditional method employing dial indicators offers a higher degree of accuracy, but it requires specialist operators and can be time consuming.

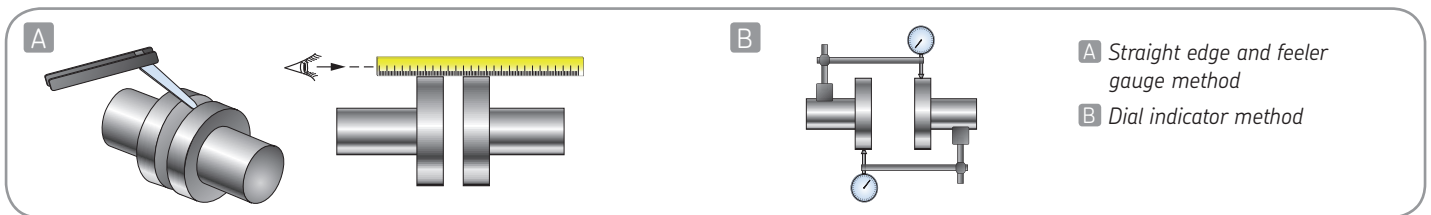

### Laser shaft alignment method

Laser alignment methods are a marked improvement on traditional ones. A laser shaft alignment tool facilitates a quicker and more accurate alignment than traditional methods. Since shaft misalignment has a direct, negative, impact on bearing service life, SKF offers a range of high precision,

easy-to-use laser shaft alignment tools. The tools, the TMEA Series, combine simplicity with a high degree of accuracy. They feature a three-step process for correcting alignment: Measuring, Aligning and Documenting.

### Accurate shaft alignment can help you:

- Increase bearing life
- Reduce stress on couplings and thereby the risk of overheating and breakage
- Reduce wear on seals, helping to prevent contamination and lubricant leakage
- Reduce friction and thereby energy consumption
- Reduce noise and vibration
- Increase machinery uptime, efficiency and productivity
- Reduce costs of replacing components and machinery downtime

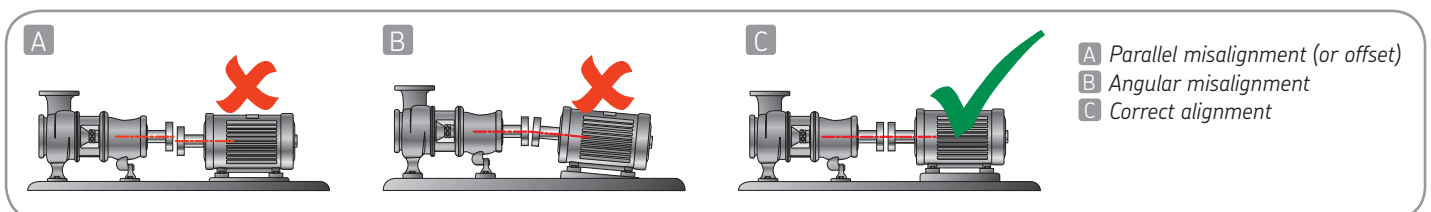

## Belt misalignment

One of the common reasons for unplanned downtime of belt-driven machinery is pulley misalignment. Pulley misalignment can increase wear on pulleys and belts as well as increasing the noise and vibration levels, which can result in unplanned machinery downtime. Another side effect of increased vibration is premature bearing failure. This too can cause unplanned machinery downtime.

### Traditional belt alignment methods

These methods, which are the most widely used, involve either using visual judgement alone or visual judgement in combination with a straight edge and/or length of string. The advantage of these traditional methods is the perceived short time needed for adjustment, although the use of a straight edge takes more time than visual judgement alone. The major disadvantage is the lack of accuracy.

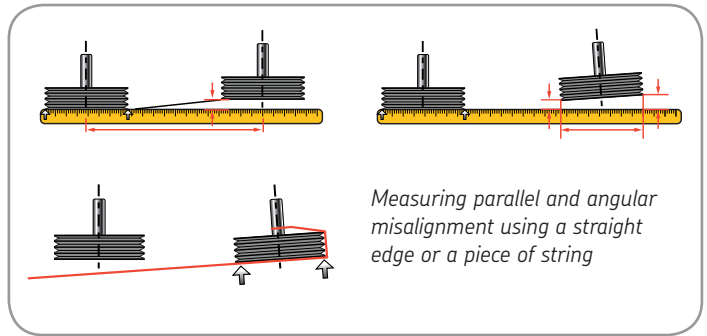

Some belt manufacturers recommend a maximum horizontal angle misalignment of 0,5° or even 0,25°, which is impossible to accomplish by using naked eye.

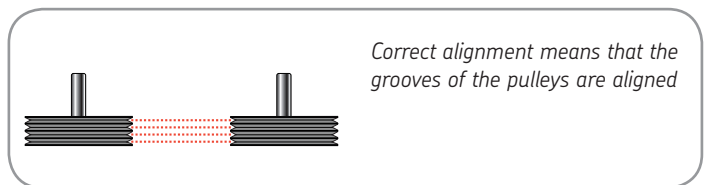

### Laser belt alignment methods

A laser belt alignment tool facilitates alignment with far more speed and accuracy than with traditional methods. Belt alignment tools available on the market can be categorised according to the way the tools can be attached to the pulley and the way they align. In general there are two groups; one aligns the face of the pulleys and the other aligns the grooves of the pulleys.

The major disadvantage of the tools, which use the face or side of the pulley as a reference for aligning the pulleys and belts, is that only the face of the pulley is used as a reference.

This means that only the faces of the pulleys are aligned with each other and not necessarily the grooves in which the belt runs. This method results in varying degrees of accuracy when the pulleys are of different thickness, brands or kinds.

The tools, which align the grooves of the pulley allow for alignment where it counts most – in the grooves of the pulley, substantially increasing accuracy irrespective of the thickness, brand or type of pulleys.

### Accurate pulley and belt alignment can help you:

- Increase bearing life
- Increase machinery uptime, efficiency and productivity
- Reduce wear on pulleys and belts

- Reduce friction and thereby energy consumption
- Reduce noise and vibration
- Reduce costs of replacing components and machinery downtime

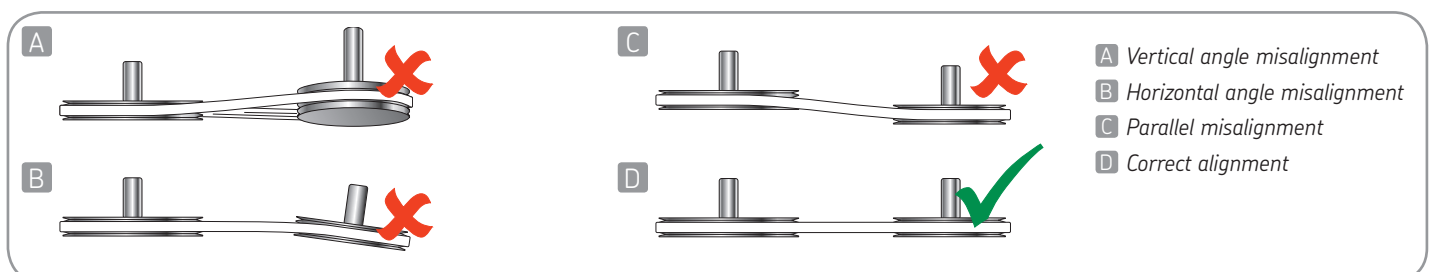



# Alignment



## Shaft alignment tools TMEA Series

### Pinpoint accurate alignment simply achieved

The SKF shaft alignment tools TMEA Series offer you simplicity with a high degree of accuracy. These highly innovative tools feature a three-step process for correcting alignment: Measuring, Aligning and Documenting. First, Measure the machinery's current alignment status.

- Easy-to-use, three-step process: Measure-Align-Document
- Compact, lightweight design
- Spirit levels allow easy and fast positioning of the measuring units
- Selectable mm or inch reading of measurement facilitates worldwide use
- Supplied in sturdy, lightweight carrying cases for portability
- Supplied with high precision SKF pre-cut shims for accurate alignment

Then Align the machine vertically and horizontally. Finally, Document and keep track of the alignment activities. These three simple steps allow you to easily and effectively align shafts using advanced laser technology.



## Shaft alignment tool TMEA 2

### Easy, quick and affordable shaft alignment

The TMEA 2 is an easy-to-use shaft alignment tool, which requires no special training to operate. The two measuring units can be easily attached to the shafts using magnetic brackets or chains. Each measuring unit emits a laser line, which is projected on the detector of the other unit.

- Display unit simultaneously provides clear "real-time" coupling and feet values during alignment process making rechecking of the alignment unnecessary
- The laser and scale lines facilitate easy pre-alignment
- "Soft foot" feature easily guides the operator through this function
- Display unit can be held using one hand, freeing the operator to perform the alignment
- Magnetic brackets allow easy fixture of the measuring units onto the shaft
- A set of blank alignment reports to help you keep record of your alignment jobs
- Maximum distance of 0,85 m (2,8 ft) between the measuring units brackets

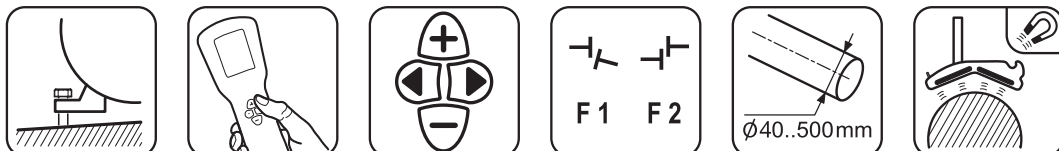

## Shaft alignment tool with printer capability TMEA 1P/2.5

### Record alignment activities using an optional printer

The TMEA 1P/2.5 offers you the advantage of keeping record of the alignment activities. It is equipped with a printer port to which the optional thermal printer TMEA P1 can be connected. The printer provides a clear and complete alignment report,

which can be used to document alignment activities.

This user-friendly printer is operated with the touch of a single button on the display unit of the TMEA 1P/2.5.

- Optional printer facilitates recording of alignment activities
- Maximum distance of 2,5 m (8,2 ft) between the measuring units makes it suitable for aligning variety of applications
- Display unit provides clear "real-time" values during the alignment process making rechecking alignment unnecessary
- User-friendly display unit with only four buttons for operation
- Supplied with blank alignment reports for recording alignment activities in case the printer is not purchased

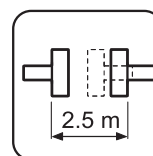
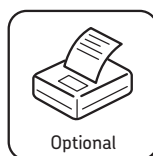
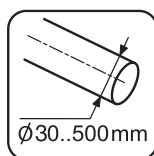

## Intrinsically safe shaft alignment tool TMEA 1PEx

### Accurate alignment in explosive hazardous areas

The TMEA 1PEx is an intrinsically safe (Ex) shaft alignment tool, especially designed for use in potentially explosive hazardous areas. It has been tested and certified according to the latest ATEX standards in intrinsic safety zones generally

found in industries such as the petrochemical, gas and pharmaceutical among others. The TMEA 1PEx is supplied standard with a thermal printer for recording alignment activities.

- Intrinsically safe classification ATEX code: II 2 G, EEx ib IIC T4, at ambient temperature range of 0 to 40 °C (32 to 104 °F) EC Type Examination Certificate Nemko03ATEX101X
- Standard printer facilitates recording of alignment activities
- Maximum distance of 1 m (3 ft) between the measuring units makes it suitable for aligning a variety of applications
- Display unit provides clear "real-time" values during the alignment process making rechecking alignment unnecessary
- User-friendly display unit with only five buttons for operation

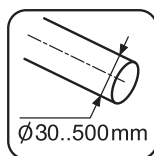



## Alignment



### Thermal printer TMEA P1

#### Keep track of alignment jobs

This compact thermal printer helps you to document your alignment jobs. A clear and complete printout of the measurement data shows that the machine has been properly aligned within the allowed tolerances.

125

- Compact easy-to-use printer
- Clear easy-to-read printout
- Pre-alignment and post-alignment reports possible
- Battery is rechargeable
- Continental European adaptor included
- Printer uses standard thermal paper roll (120 mm × 20 m) / (4,4 in × 65 ft)
- Can be used in combination with TMEA 1P/2.5 and TMEA 1PEX only



### Machinery shims TMAS series

#### For accurate vertical machinery alignment

Accurate machine adjustment is an essential element of any alignment process. SKF single slot pre-cut shims are available in five different dimensions and in ten different thicknesses.

127

- Made of high quality stainless steel, allowing re-use
- Easy to fit and to remove
- Close tolerances for accurate alignment
- Thickness clearly marked on each shim
- Fully de-burred
- Pre-cut shims are supplied in packs of 10 and complete kits are also available



## Contents TMAS shim kits

### TMAS 340

Thickness (mm)	0,05	0,10	0,20	0,25	0,40	0,50	0,70	1,00	2,00
<b>Size (mm)</b>	<b>Quantities:</b>								
100 × 100	20	20	20	20	20	20	20	20	10
125 × 125	20	20	20	20	20	20	20	20	10

### TMAS 360

Thickness (mm)	0,05	0,10	0,25	0,50	1,00	2,00
<b>Size (mm)</b>	<b>Quantities:</b>					
50 × 50	20	20	20	20	20	20
75 × 75	20	20	20	20	20	20
100 × 100	20	20	20	20	20	20

### TMAS 510

Thickness (mm)	0,05	0,10	0,20	0,25	0,40	0,50	0,70	1,00	2,00
<b>Size (mm)</b>	<b>Quantities:</b>								
50 × 50	20	20	20	20	20	20	20	20	10
75 × 75	20	20	20	20	20	20	20	20	10
100 × 100	20	20	20	20	20	20	20	20	10

### TMAS 720

Thickness (mm)	0,05	0,10	0,20	0,25	0,40	0,50	0,70	1,00	2,00
<b>Size (mm)</b>	<b>Quantities:</b>								
50 × 50	20	20	20	20	20	20	20	20	20
75 × 75	20	20	20	20	20	20	20	20	20
100 × 100	20	20	20	20	20	20	20	20	20
125 × 125	20	20	20	20	20	20	20	20	20

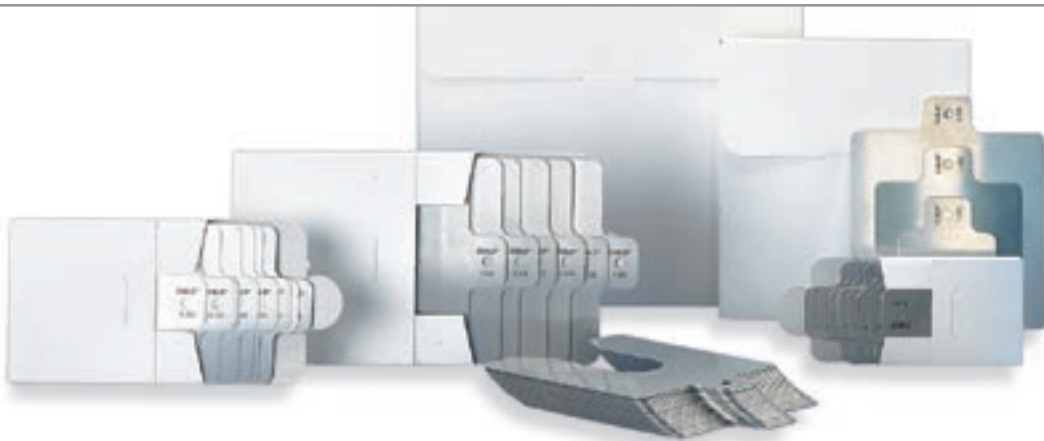

TMAS 340



TMAS 360



TMAS 510



TMAS 720





## Alignment



### Belt alignment tool BeltAlign TMEB 2

#### Belt-driven machinery downtime caused by misalignment is a thing of the past

The SKF BeltAlign, TMEB 2, aligns the pulleys where it counts most – in the grooves. V-guides and powerful magnets allow the BeltAlign to be fitted in the grooves of the pulley. With only two components, a laser-emitting unit and a receiver unit, the BeltAlign is easy and fast to attach. The three-dimensional target area on the receiver unit allows the easy

detection of misalignment as well as its nature; whether it is horizontal, vertical, parallel or a combination of all three. Armed with this precise information, the operator can easily make the appropriate adjustments until the laser line corresponds with the reference line on the receiver unit.

#### Versatile and user-friendly:

- Powerful magnets allow fast and easy attachment
- Easy-to-use, requires no special training to operate
- Three-dimensional target area simplifies the alignment process
- Facilitates simultaneous adjustment of tension and alignment
- V-guides facilitate the alignment of a wide range of V-belt pulleys
- Special side adaptor allowing alignment of multi-ribbed and timing belt pulleys as well as chain sprockets is available as accessory
- A maximum operating distance of 6 meters (20 ft) makes it suitable for use in various applications
- Sturdy aluminium housings provide great assembly stability and accuracy

#### Pinpoint accuracy with latest laser technology:

- Aligns grooves of the pulley rather than its face, allowing the alignment of pulleys of unequal width or with dissimilar faces – even fits applications where the pulley face cannot be used as a reference
- No trial and error. The laser position indicates the nature of misalignment allowing easy and accurate adjustment





# Re-lubrication

## **SKF bearing greases:**

### **The perfect solution for every application**

Glossary of lubrication terms	50
Basic bearing grease selection	52
SKF bearing grease selection chart	57
SKF bearing greases and their applications	58
SYSTEM 24 single-point automatic lubricator	60
LAGD 125 and LAGD 60	66
SKF Chain oil range	69
Re-lubrication calculation program DialSet 3.0	70
SYSTEM MultiPoint automatic lubricator LAGD 400	71
Oil Leveller LAHD series	72
Grease packer LAGP 400	72
Grease gun 1077600	73
One hand operated grease gun LAGH 400	73
Bearing packer VKN 550	74
Disposable grease resistant gloves TMBA G11D	74
Grease meter LAGM 1000E	74
Grease filler pumps LAGF series	75
Grease pumps LAGG series	75
1 kg grease pump LAGG 1M	76
Lubrication accessory sets	76



## SKF bearing greases: The perfect solution for every application

Even the very best bearing can only show optimum performance when it is lubricated correctly. Here, it is extremely important to choose the right bearing grease and to apply the most suitable lubrication intervals and methods. This realisation has prompted SKF, the world's leading manufacturer of rolling bearings, to look intensively into the subject of lubrication. SKF engineers consider grease to be a "fundamental" component of the bearing arrangement and thus, as important as the bearing, housing and sealing. SKF's vast experience in the development of rolling bearings forms the basis for the development of a special range of lubricants, the superior quality of which is obtained through continuous testing and studies.

### SKF sets the standard

Tangible performance parameters mean more to SKF than the chemical composition of the lubricant. The chemical composition is not the only factor in determining the quality of a particular grease, since modern lubricants are extremely complex. SKF has set the standards for developing special testing parameters.

### Bearing grease selection

Incorrect lubrication accounts for up to 36 % of premature bearing failures. All-purpose greases are inadequate for specialised bearing needs and can cause problems rather than be beneficial. Bearing applications have wide variations of operating conditions and correct lubrication calls for matching the grease precisely to the application.

The strict standards and testing parameters developed and applied at the SKF Engineering and Research Centre have become internationally recognised benchmarks for bearing greases. The comprehensive range of SKF bearing greases is the result of many decades of research and development. Each individual lubricant is precisely adjusted to the respective field of application.

Bearing greases help ensure smooth, trouble-free operation and maximum reliability even under the most extreme conditions. They help prevent contamination from penetrating the bearing, cushion any shock loads and protect against corrosion. Selecting the right bearing grease for a certain application is essential for achieving the maximum service life of a bearing.

Selection criteria for correct lubrication include bearing type and size, temperatures, speeds and loads, as well as the desired service life and re-lubrication intervals.

### SKF Traffic light concept and Grease Performance Factor

The temperature range over which a grease can be used depends largely on the type of base oil and thickener used as well as the additives. The relevant temperatures are schematically illustrated in the following diagrams in the form of a "double traffic light".



## Operating temperature range of greases: The SKF Traffic Light Concept

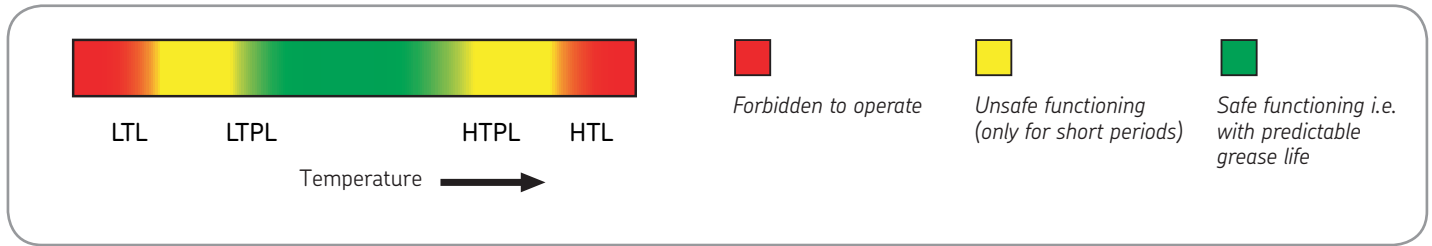

### LTL – Low-temperature limit:

The lowest temperature at which the grease will allow the bearing to be started up without difficulty.

### LTPL – Low-temperature performance limit:

Below this limit, the supply of grease to the contact surfaces of rolling elements and raceways may become insufficient. Values are different for roller and ball bearings.

### HTPL – High-temperature performance limit:

Above this limit the grease will oxidise in an uncontrolled way, so that grease life cannot be determined accurately.

### HTL – High-temperature limit:

When exceeding this limit, the grease loses its structure permanently (e.g., the dropping point for soap-base greases).

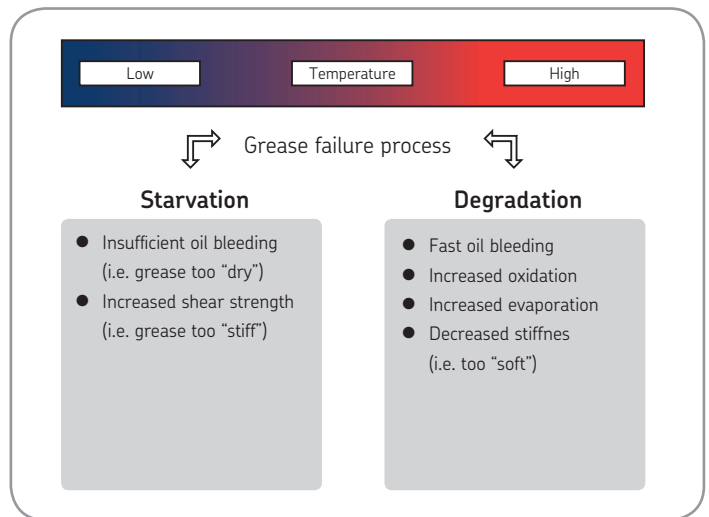
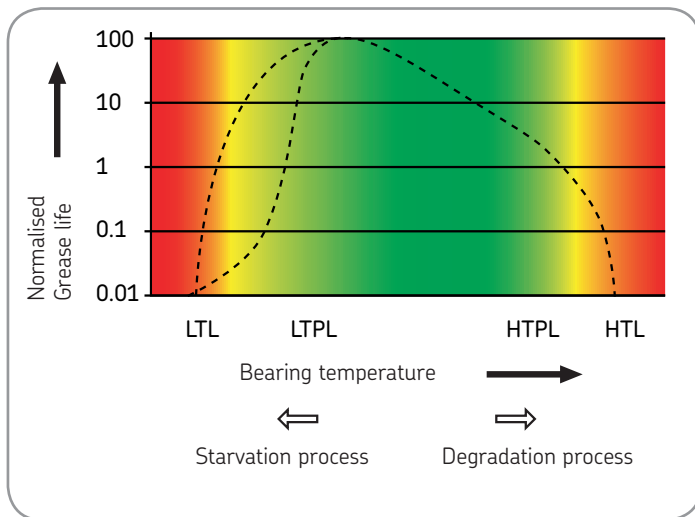

## Effect of temperature on grease functioning

The values shown in these diagrams are based on extensive tests conducted in SKF laboratories. These tests allow us to accurately determine the temperature range of the SKF bearing greases given in the selection charts included in this catalogue.

The results of these tests are also used to evaluate the grease life. The performance of each grease is then translated into a Grease Performance Factor (GPF). Greases with highest values offer the longest life. This factor, used in correlation with the SKF re-lubrication diagram (see SKF General Catalogue GC 5000), allows you to determine the correct re-lubrication intervals for the chosen grease.

## Re-lubrication intervals

Choosing the right bearing grease for a certain application is critical to bearing performance. Applying the correct quantity of grease at the right intervals is of equal importance. Over- or under-greasing as well as inadequate lubrication methods can shorten the bearing's service life. For determining the right amount of grease and the correct re-lubrication intervals for a specific application, SKF has developed DialSet, a simple computerised re-lubrication calculation program. Calculated re-lubrication intervals are based on the latest lubrication theories published in the SKF General Catalogue (GC 5000) and depend on bearing type used, application conditions and properties of selected bearing grease.



# Re-lubrication



## Lubrication methods

The lubrication method used is equally important to the right bearing grease, quantity and lubrication intervals. Using lubricators, manual or automatic, facilitates proper lubricant supply to the application. Maintaining cleanliness when lubricating bearings is crucial, as contamination can cause the bearing to fail prematurely.

Using a grease meter in combination with a grease gun or pump during manual lubrication helps ensure the supply of the right quantity of grease. SKF's range of grease guns, pumps and lubrication accessories is designed for contamination-free grease supply as well as ease-of-use.

Continuous lubrication using automatic lubricators, single or multiple-point, provides the application with consistent and controlled supply of bearing grease. This reduces the risk of over- or under-greasing and positively contributes to optimising the bearing's service life. Additionally, automatic re-lubrication reduces the risk of contamination. Around the clock solutions offered by SKF, such as SYSTEM 24 and SYSTEM MultiPoint, provide precise and reliable grease supply, exactly adjusted to the application's needs.

# Glossary of lubrication terms

## Thickener or soap

Thickener or soap is the system, which holds the oil and/or additives together to enable the lubricating grease to function. The thickener system is formed from either soaps or non-soaps. The type of thickener gives the grease its typical characteristics.

Soaps are based on lithium, calcium, sodium, barium, or aluminium. Non-soaps are based on organic or non-organic solids, bentonite clay, polyurea, silica gel.

## Thickener compatibility chart

	Lithium	Calcium	Sodium	Lithium complex	Calcium complex	Sodium complex	Barium complex	Aluminium complex	Clay	Common Polyurea	Calcium sulphonate complex
Lithium	+	○	–	+	–	○	○	–	○	○	+
Calcium	○	+	○	+	–	○	○	–	○	○	+
Sodium	–	○	+	○	○	+	+	–	○	○	–
Lithium complex	+	+	○	+	+	○	○	+	–	–	+
Calcium complex	–	–	○	+	+	○	–	○	○	+	+
Sodium complex	○	○	+	○	○	+	+	–	–	○	○
Barium complex	○	○	+	○	–	+	+	+	○	○	○
Aluminium complex	–	–	–	+	○	–	+	+	–	○	–
Clay	○	○	○	–	○	–	○	–	+	○	–
Common Polyurea	○	○	○	–	+	○	○	○	○	+	+
Calcium sulphonate complex	+	+	–	+	+	○	○	–	–	+	+

+ = Compatible    ○ = Test required    – = Incompatible

*Note: SKF high performance, high temperature bearing grease LGHP 2 is not a common polyurea type grease. It is a di-urea bearing grease, which has successfully been tested for compatibility*

*with lithium and lithium complex thickened greases i.e. LGHP 2 is compatible with such greases.*

## Base oil compatibility chart

	Mineral/PAO	Ester	Polyglycol	Silicone: Methyl	Silicone: Phenyl	Polyphenyl-ether	PFPE
Mineral oil / PAO	+	+	—	—	+	○	—
Ester	+	+	+	—	+	○	—
Polyglycol	—	+	+	—	—	—	—
Silicone: methyl	—	—	—	+	+	—	—
Silicone: phenyl	+	+	—	+	+	+	—
Polyphenylether	○	○	—	—	+	+	—
PFPE	—	—	—	—	—	—	+

+ = Compatible    ○ = Test required    — = Incompatible

### Base oil

The base oil is the oil inside the grease, which provides the lubrication under the operating conditions. Greases are normally based on mineral oils. Synthetic oils can be used for very specific applications such as extremely high or low temperatures. The base oil generally constitutes more than 70% of a grease's composition.

### Base oil viscosity

Viscosity is a measure of a fluid's flow characteristics and is usually expressed in terms of the time required for a standard quantity of the fluid, at a given temperature, to flow through a standard orifice. Since viscosity decreases with increasing temperature, the temperature at which it is measured is always stated. The viscosity of base oils is always indicated as a kinematic viscosity abbreviated to cSt, at 40 °C and often also at 100 °C.

### Additives

Additives are used to provide additional characteristics such as wear and corrosion protection, friction reducing effects and preventing damage under boundary and mixed lubrication conditions.

### Grease consistency/penetration

A measure of the stiffness of a grease. The consistency is classified according to a scale developed by the NLGI (National Lubricating Grease Institute). This is based on the degree of penetration achieved by allowing a standard cone to sink into the grease at a temperature of 25 °C for a period of five seconds. The depth of penetration is measured on a scale of  $10^{-1}$  mm and the softer greases allow the cone to penetrate further into the grease, hence the higher penetration number. The test method is in accordance to DIN ISO 2137.

### DIN 51825 Classification system

Bearing greases can be classified according to DIN 51825. The explanation of the DIN code KP2G-20 is given in the below tables.

### Drop point

The drop point is the temperature at which the grease sample, when heated, will begin to flow through an opening and is measured according to DIN ISO 2176. The drop point does not relate to the allowable operating service temperature of the grease.

### Mechanical stability

The consistency of a rolling bearing grease should not alter, or only slightly, during the working life of the rolling bearing. Depending on the application, the following tests can be relevant to evaluate the mechanical stability of a grease.

### Prolonged penetration

The grease sample is filled into a cup and using an automatic device (called a grease worker) subjected to 100 000 double strokes. At the end of the test the penetration of the grease is measured. The difference between the measured penetration at 60 strokes and after 100 000 strokes penetration is reported as the change in  $10^{-1}$  mm.





# Re-lubrication



## DIN 51825 – for example: K P 2 G – 20

Application area DIN 51825	K	K= Greases for bearings G= Grease for closed gears OG= Greases for open gears M= Greases for friction bearings/sealing
Additional information	P	P= EP additives F= Solid lubricants E= Ester
NLGI Grade	2	(see NLGI classification)
Upper operating temperature and water resistance	G	(see next table)
Lower operating temperature	-20	-20 °C

## Third designation letter

Letter	Upper operating temperature (°C)	Water resistance DIN 51807
C	+60	0 – 40 to 1 – 40
D	+60	2 – 40 to 3 – 40
E	+80	0 – 40 to 1 – 40
F	+80	2 – 40 to 3 – 40
G	+100	0 – 90 to 1 – 90
H	+100	2 – 90 to 3 – 90
K	+120	0 – 90 to 1 – 90
M	+120	2 – 90 to 3 – 90
N	+140	No requirement
P	+160	No requirement
R	+180	No requirement
S	+200	No requirement
T	+220	No requirement
U	>+220	No requirement

## Classification of greases by NLGI consistency number

NLGI number	ASTM worked penetration (10 <sup>-1</sup> mm)	Appearance at room temperature	NLGI number	ASTM worked penetration (10 <sup>-1</sup> mm)	Appearance at room temperature
000	445 – 475	very fluid	3	220 – 250	medium hard
00	400 – 430	fluid	4	175 – 205	hard
0	355 – 385	semi-fluid	5	130 – 160	very hard
1	310 – 340	very soft	6	85 – 115	extremely hard
2	265 – 295	soft			

### Roll stability

The change in the grease structure (amount of softening or hardening) can be evaluated by filling a cylinder with a pre-specified quantity of grease. A roller is placed inside the cylinder and the complete unit is rotated for 2 hours at room temperature in accordance with ASTM D 1403. SKF modified the standard test procedure to reflect the application conditions under which the grease is used to either 72 or 100 hours at a test temperature of 80 or 100 °C. At the end of the test period the cylinder is allowed to cool to room temperature and the penetration of the grease is measured. The difference between the original penetration and the value measured is reported as the change in penetration in 10<sup>-1</sup> mm.

### SKF V2F test

The candidate grease is tested for mechanical stability using the following procedure. The test rig consists of a railway axlebox subjected to vibration shocks of 1Hz from a bouncing hammer producing an acceleration level between 12 – 15 g. The test is run at two different speeds, 500 and 1 000 rpm. If the grease, which leaks from the housing through the labyrinth seal which is collected in a tray after 72 hours at 500 rpm, weighs less than 50 grams the test is continued for a further 72 hours at 1 000 rpm. If the total amount of grease leakage after both tests (72 hours at both 500 and 1 000 rpm) does not exceed 150 grams then a rating of 'M' is given. If the grease only fulfils the first part of the test (72 hours at 500 rpm with a grease leakage of 50 grams or less) but fails the second stage, a rating of 'm' is given. If the grease leakage after 72 hours at 500 rpm is greater than 50 grams then it is rated a 'fail'.

## Corrosion protection

Lubricating greases should protect metal surfaces from corrosive attack in service. The corrosion protection properties of rolling bearing greases are evaluated using the SKF Emcor method, which is standardised under ISO 11007. Under this test method a mixture of lubricating grease and distilled water is present in the bearing. The bearing alternates during a defined test cycle between standstill and rotation at 80 rpm. At the end of the test cycle the degree of corrosion is evaluated according to a scale between 0 (no corrosion) and 5 (very severe corrosion). A more severe test method is to use salt water to replace the distilled water following the standard test procedure. In addition the test can also be carried out by continuously allowing water to flow or wash through the bearing arrangement during the test cycle.

This test method is called the SKF Distilled Water Washout Test. The evaluation procedure is exactly the same as that used under the standardised method. However the procedure places greater demands on the corrosion protection properties of the grease.

## Copper corrosion

Lubricating greases should protect copper alloys used in bearings from corrosive attack while in service. The copper corrosion protection properties of rolling bearing greases are evaluated using the standardised method DIN 51811. A copper strip is immersed in the grease sample and placed in an oven. The strip is then cleaned and the degradation is observed. The result is rated by a numerical system.

## Water resistance

The water resistance of lubricating greases is measured in accordance with DIN 51 807 part 1. A glass strip is coated with the candidate grease, which is placed into a water-filled test tube. The test tube is immersed in a water bath for three hours at a specified test temperature. The change in the grease is evaluated visually and reported as a value between 0 (no change) and 3 (major change) along with the test temperature.

## Oil separation

Lubricating greases release oil when stored for long periods of time or when used in bearings as a function of temperature. This phenomenon is necessary to ensure good lubrication. The degree of oil separation will depend upon the thickener, base oil and manufacturing method. A cup is filled with a given quantity of grease (which is weighed before the test) and a 100 gram weight placed on top of the grease. The complete unit is put into an oven at 40 °C for one week. At the end of the week the amount of oil, which has leaked through the sieve is weighed and reported as a percentage of weight loss. The amount of oil separation is measured in accordance with DIN 51 817.

### Test for oil bleeding rate

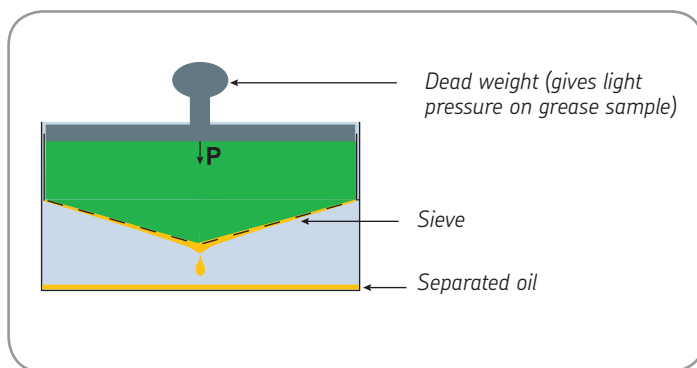

DIN 51 817: determination of the % oil separated after one week at 40 °C

### Test for water resistance of greases

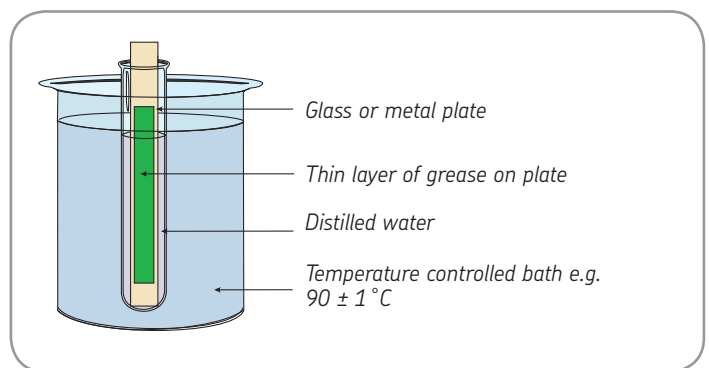

DIN 51 807: rating for degree of grease deterioration in water





# Re-lubrication



## Lubricating ability

The SKF R2F machine assesses the high temperature performance and lubricating ability of a grease, simulating the conditions under which large size bearings operate in housings. The test method is carried out under two different conditions. Test A is conducted at ambient temperature and Test B is conducted at 120 °C. A pass rating in the unheated test (Test A) means that a grease can be used to lubricate larger rolling bearings at normal operating temperatures and also in low vibrating applications. A pass in the heated test (Test B) at 120 °C means that the grease is suitable for use in large roller bearings operating at elevated temperatures.

## Rolling bearing grease life

The SKF R0F grease test machine determines the grease life and high temperature performance limit of a lubricating grease. Ten deep groove ball bearings are fitted into 5 housings and filled with a given quantity of grease. The test is undertaken at a pre-determined speed and temperature. Both an axial and radial load is applied and the bearings run until failure. The time to failure is recorded in hours and a Weibull life calculation is made at the end of the test period to establish the grease life. This information can then be used in the determination of re-lubrication intervals in an application.

## EP performances

The 4-ball weld load test.

This method evaluates the EP (Extreme Pressure) performance of a lubricating grease. This test method is standardised under DIN 51 350/4. Three steel balls are held in a cup and another fourth ball is rotated against the three balls at a given speed. A starting load is applied and increased at predetermined intervals until the rotating ball siezes and welds to the three stationary balls. The test indicates the point at which the extreme pressure limit of the grease is exceeded. Greases can be considered as EP greases when the weld load is higher than 2600 N.

## The 4-ball wear scar test

This test is performed with the same rig used in the 4-ball weld load test. 1400 N are applied on the fourth ball during 1 minute. Then the wear on the three balls is measured. Standard test uses a load of 400 N. However, SKF has decided to increase that to 1400 N in order to make the test relevant for bearing applications.

## False Brinelling

Anti-fretting properties of a grease can be relevant for certain applications. SKF can assess these properties using the FAFNIR test standardised as ASTM D4170. Two ball thrust bearings are loaded and oscillated. The wear on each bearing is then measured. Greases offer good fretting protection when the measured wear is below 7 mg.



# Basic bearing grease selection

Generally use if: Speed = M, Temperature = M and Load = M

**LGMT 2**

General purpose

Unless:

Expected bearing temperature continuously > 100 °C / 212 °F

**LGHP 2**

High temperature

Expected bearing temperature continuously > 150 °C / 302 °F, demands for radiation resistance

**LGET 2**

Extremely high temperature

Low ambient -50 °C / -58 °F, expected bearing temperature < 50 °C / 122 °F

**LGLT 2**

Low temperature

Shock loads, heavy loads, frequent start-up / shut-down

**LGEP 2**

High load

Food processing industry

**LGFP 2**

Food processing

"Green" biodegradable, demands for low toxicity

**LGGB 2**

"Green" biodegradable

Note: – For areas with relatively high ambient temperatures, use LGMT 3 instead of LGMT 2  
– For special operating conditions, refer to the SKF bearing grease selection chart

## Bearing operating parameters

### Temperature

L = Low  
M = Medium  
H = High  
EH = Extremely high

<50 °C / 122 °F  
50 to 100 °C / 122 to 230 °F  
>100 °C / 212 °F  
> 150 °C / 302 °F

### Speed for ball bearings

EH = Extremely High  
VH = Very High  
H = High  
M = Medium  
L = Low

n.dm over 700 000  
n.dm up to 700 000  
n.dm up to 500 000  
n.dm up to 300 000  
n.dm below 100 000

### Speed for roller bearings

H = High  
M = Medium  
L = Low  
VL = Very Low

#### SRB/TRB/CARB®

n.dm over 210 000  
n.dm up to 210 000  
n.dm up to 75 000  
n.dm below 30 000

#### CRB

n.dm over 270 000  
n.dm up to 270 000  
n.dm up to 75 000  
n.dm below 30 000

### Load

VH = Very high  
H = High  
M = Medium  
L = Low

C/P < 2  
C/P ~ 4  
C/P ~ 8  
C/P 15

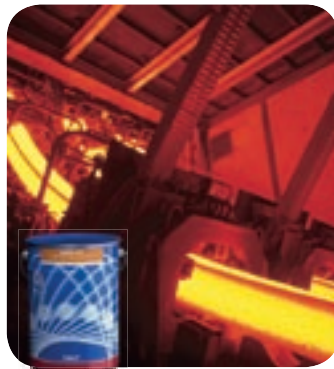



# Re-lubrication



SKF bearing grease selection chart

Bearing working conditions	Temp	Speed	Load	Vertical shaft	Fast outer ring rotation	Oscillating movements	Severe vibrations	Shock load or frequent start-up	Low noise	Low friction
<b>LGMT 2</b>	M	M	L to M	○	-	-	+	-	-	○
<b>LGMT 3</b>	M	M	L to M	+	○	-	+	-	-	○
<b>LGEP 2</b>	M	L to M	H	○	-	○	+	+	-	-
<b>LGFP 2</b>	M	M	L to M	○	-	-	-	-	-	○
<b>LGEM 2</b>	M	VL	H to VH	○	-	+	+	+	-	-
<b>LGEV 2</b>	M	VL	H to VH	○	-	+	+	+	-	-
<b>LGLT 2</b>	L to M	M to EH	L	○	-	-	-	○	+	+
<b>LGGB 2</b>	L to M	L to M	M to H	○	-	+	+	+	-	○
<b>LGWM 1</b>	L to M	L to M	H	-	-	+	-	+	-	-
<b>LGWA 2</b>	M to H	L to M	H	○	○	○	○	+	-	○
<b>LGHB 2</b>	M to H	VL to M	H to VH	○	+	+	+	+	-	-
<b>LGHP 2</b>	M to H	M to H	L to M	+	-	-	+	○	+	○
<b>LGET 2</b>	VH	L to M	H to VH	○	+	+	○	○	-	-

(\*1) Grease Performance Factor

(\*2) for information on safe operating temperature please refer to pages 50 – 51

(\*3) mm<sup>2</sup>/s at 40 °C / 104 °F = cSt.

(\*4) LGGB 2 can withstand peak temperatures of 120 °C / 250 °F

(\*5) LGWA 2 can withstand peak temperatures of 220 °C / 428 °F

(\*6) LGHB 2 can withstand peak temperatures of 200 °C / 392 °F

(\*7) Contact SKF for re-lubrication intervals

Rust inhibiting properties	GPF (*1)	Description	Temperature range (*2)		Thickener / base oil	Base oil viscosity (*3)
			LTL	HTPL		
+	1	General purpose industrial and automotive	-30 °C -22 °F	120 °C 250 °F	Lithium soap/ mineral oil	110
○	1	General purpose industrial and automotive	-30 °C -22 °F	120 °C 250 °F	Lithium soap/ mineral oil	120
+	1	Extreme pressure	-20 °C -4 °F	110 °C 230 °F	Lithium soap/ mineral oil	200
+	0,7	Food compatible	-20 °C -4 °F	110 °C 230 °F	Aluminium complex/medical white oil	130
+	1	High viscosity plus solid lubricants	-20 °C -4 °F	120 °C 250 °F	Lithium soap/ mineral oil	500
+	1	Extremely high viscosity with solid lubricants	-10 °C -14 °F	120 °C 250 °F	Lithium-calcium soap/ mineral oil	1 020
○	2	Low temperature, extremely high speed	-50 °C -58 °F	110 °C 230 °F	Lithium soap / PAO oil	18
○	0,7	Green biodegradable, low toxicity	-40 °C -40 °F	90 °C (*4) 194 °F	Lithium-calcium soap / synthetic ester oil	110
+	1	Extreme pressure, low temperature	-30 °C -22 °F	110 °C 230 °F	Lithium soap / mineral oil	200
+	1,5	Wide temperature (*5), extreme pressure	-30 °C -22 °F	140 °C 284 °F	Lithium complex soap / mineral oil	185
+	1,7	EP high viscosity, high temperature (*6)	-20 °C -4 °F	150 °C 302 °F	Complex calcium sulphonate / mineral oil	400
+	2	High performance polyurea grease	-40 °C -40 °F	150 °C 302 °F	Di-urea / mineral oil	96
○	(*7)	Extreme temperature	-40 °C -40 °F	260 °C 500 °F	PTFE / synthetic (fluorinated polyether)	400

+

= Recommended



= Suitable



= Not suitable



# SKF Bearing greases and their applications

## LGMT 2

### SKF general purpose industrial and automotive bearing grease

LGMT 2 is mineral oil based lithium soap thickened grease with excellent thermal stability within its operating temperature range. This premium quality, general purposes grease is suitable for a wide range of industrial and automotive applications.

- Excellent oxidation stability
- Good mechanical stability
- Excellent water resistance and rust inhibiting properties

#### Typical applications:

- Agricultural equipment
- Automotive wheel bearings
- Conveyors
- Small electric motors
- Industrial fans



#### Bearing operating conditions

Temperature	Medium
Speed	Medium
Load	Low to Medium
Vertical shaft	○
Fast outer ring rotation	—
Oscillating movements	—
Severe vibrations	+
Shock load or frequent start-up	—
Low noise	—
Low friction	○
Rust inhibiting properties	+
+ = Recommended    ○ = Suitable    — = Not suitable	

#### Available pack sizes LGMT 2

	35 g tube	200 g tube
420 ml cartridge	1 kg can	5 kg can
18 kg can	50 kg drum	180 kg drum

## LGMT 3

### SKF general purpose industrial and automotive bearing grease

LGMT 3 is mineral oil based lithium soap thickened grease. This premium quality, general purposes grease is suitable for a wide range of industrial and automotive applications.

- Excellent rust inhibiting properties
- High oxidation stability within its recommended temperature range

#### Typical applications:

- Bearings >100 mm (3,9 in) shaft size
- Outer bearing ring rotation
- Vertical shaft applications
- Continuous high ambient temperatures >35 °C (95 °F)
- Propeller shafts
- Agricultural equipment
- Car, truck and trailer wheel bearings
- Large electric motors



#### Bearing operating conditions

Temperature	Medium
Speed	Medium
Load	Low to Medium
Vertical shaft	+
Fast outer ring rotation	○
Oscillating movements	—
Severe vibrations	+
Shock load or frequent start-up	—
Low noise	—
Low friction	○
Rust inhibiting properties	○
+ = Recommended    ○ = Suitable    — = Not suitable	

#### Available pack sizes LGMT 3

	1 kg can	5 kg can
420 ml cartridge	50 kg drum	180 kg drum

## LGEP 2

### SKF high load, extreme pressure (EP) bearing grease

LGEP 2 is mineral oil based lithium soap thickened grease with extreme pressure additives. This grease provides good lubrication in operating temperatures ranging from  $-20\text{ }^{\circ}\text{C}$  ( $-4\text{ }^{\circ}\text{F}$ ) up to  $110\text{ }^{\circ}\text{C}$  ( $230\text{ }^{\circ}\text{F}$ ).

- Excellent mechanical stability
- Extremely good corrosion inhibiting properties
- Excellent EP performance

#### Typical applications:

- Pulp and paper making machines
- Jaw crushers
- Traction motors for rail vehicles
- Dam gates
- Work roll bearings in steel industry
- Heavy machinery, vibrating screens
- Crane wheels, sheaves



#### Bearing operating conditions

Temperature	Medium
Speed	Low to Medium
Load	High
Vertical shaft	○
Fast outer ring rotation	—
Oscillating movements	○
Severe vibrations	+
Shock load or frequent start-up	+
Low noise	—
Low friction	—
Rust inhibiting properties	+
+ = Recommended    ○ = Suitable    — = Not suitable	

#### Available pack sizes LGEP 2

420 ml cartridge	1 kg can	5 kg can
18 kg can	50 kg drum	180 kg drum

## LGFP 2

### SKF food compatible bearing grease

LGFP 2 is clean, non-toxic bearing grease, which is based on medical white oil using an aluminium complex soap. This grease is formulated using only FDA\* listed ingredients and is authorised by the NSF\*\* for category H1\*\*\* service.

- Compliance with all existing legislation on food protection
- High resistance to water washout making it suitable for applications subject to frequent wash down
- Excellent grease life
- Excellent corrosion resistance
- An essentially neutral pH value

#### Typical applications:

- Bakery equipment
- Food processing equipment
- Multi-pack cassette bearings
- Wrapping machines
- Conveyor bearings
- Bottling machines

- \* FDA – Food and Drug Administration
- \*\* NSF – National Sanitation Foundation
- \*\*\* H1 – Incidental Contact with Food



#### Bearing operating conditions

Temperature	Medium
Speed	Medium
Load	Low to Medium
Vertical shaft	○
Fast outer ring rotation	—
Oscillating movements	—
Severe vibrations	—
Shock load or frequent start-up	—
Low noise	—
Low friction	○
Rust inhibiting properties	+
+ = Recommended    ○ = Suitable    — = Not suitable	

#### Available pack sizes LGFP 2

SYSTEM 24	420 ml cartridge
1 kg can	18 kg can
180 kg drum	



# Re-lubrication



## LGEM 2

### SKF High viscosity bearing grease with solid lubricants

LGEM 2 is a premium quality, high viscosity, mineral oil based grease using a lithium soap containing molybdenum disulphide and graphite.

- Good lubrication for bearings operating under high loads and slow rotations
- Safe lubrication due to the inclusion of molybdenum disulphide and graphite

#### Typical applications:

- Rolling element bearings running at low speed and very high loads
- Jaw crushers
- Track laying machines
- Lift mast wheels
- Building machines such as mechanical rams, crane arms and crane hooks

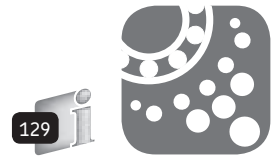

#### Bearing operating conditions

Temperature	Medium
Speed	Very Low
Load	High to Very High
Vertical shaft	○
Fast outer ring rotation	—
Oscillating movements	+
Severe vibrations	+
Shock load or frequent start-up	+
Low noise	—
Low friction	—
Rust inhibiting properties	+
+ = Recommended    ○ = Suitable    — = Not suitable	

#### Available pack sizes LGEM 2

SYSTEM 24		
420 ml cartridge	5 kg can	18 kg can
		180 kg drum

## LGEV 2

### SKF Extremely high viscosity bearing grease with solid lubricants

LGEV 2 is a premium quality, extremely high viscosity, mineral oil based grease using a lithium–calcium soap containing molybdenum disulphide and graphite.

- Excellent lubrication properties due to the inclusion of molybdenum disulphide and graphite solid
- Extremely suitable for lubricating large sized spherical roller bearings subject to high loads and slow rotations, a situation where microslip is likely to occur
- Extremely mechanically stable providing good water resistance and corrosion protection

#### Typical applications:

- Trunnion bearings on rotating drums
- Support and thrust rollers on rotary kilns and dryers
- Bucket wheel excavators
- Slewing ring bearings
- High pressure roller mills
- Crushers



#### Bearing operating conditions

Temperature	Medium
Speed	Very Low
Load	High to Very High
Vertical shaft	○
Fast outer ring rotation	—
Oscillating movements	+
Severe vibrations	+
Shock load or frequent start-up	+
Low noise	—
Low friction	—
Rust inhibiting properties	+
+ = Recommended    ○ = Suitable    — = Not suitable	

#### Available pack sizes LGEV 2

35 g tube		
420 ml cartridge		5 kg can
18 kg can	50 kg drum	180 kg drum

## LGLT 2

### SKF low temperature, extremely high speed bearing grease

LGLT 2 is premium quality, fully synthetic oil based grease using lithium soap. Its unique thickener technology and its low viscosity oil (PAO) provide excellent lubrication performances at low temperatures (–50 °C) and extremely high speeds n.d.m values of  $1.6 \times 10^6$  can be reached.

- Low friction torque
- Low level of power loss
- Quiet running behaviour
- Extremely good oxidation stability and resistance to water

#### Typical applications:

- Textile spinning spindles
- Machine tool spindles
- Instruments and control equipment
- Small electric motors used in medical and dental equipment
- In-line skates
- Printing cylinders
- Robots



#### Bearing operating conditions

Temperature	Low to Medium
Speed	Medium to Extremely High
Load	Low
Vertical shaft	○
Fast outer ring rotation	—
Oscillating movements	—
Severe vibrations	—
Shock load or frequent start-up	○
Low noise	+
Low friction	+
Rust inhibiting properties	○
+ = Recommended    ○ = Suitable    — = Not suitable	

#### Available pack sizes LGLT 2

	200 g tube
1 kg can	
25 kg can	180 kg drum

## LGGB 2

### SKF green biodegradable bearing grease

LGGB 2 is biodegradable, low toxicity, synthetic ester oil based grease using a lithium–calcium thickener. It has excellent lubrication properties for a wide range of applications operating under different conditions.

- Compliance with current regulations on toxicity and biodegradability
- Good performance in applications with steel–on–steel spherical plain bearings, ball bearings and roller bearings
- Good low temperature start-up performance
- Good corrosion inhibiting properties
- Suitable for medium to high loads

#### Typical applications:

- Agricultural and forestry equipment
- Construction and earthmoving equipment
- Mining and conveying equipment
- Water treatment and irrigation
- Locks, dams, bridges
- Linkages, rod ends
- Other applications where contamination of the environment is a concern



#### Bearing operating conditions

Temperature	Low to Medium
Speed	Low to Medium
Load	Medium to High
Vertical shaft	○
Fast outer ring rotation	—
Oscillating movements	+
Severe vibrations	+
Shock load or frequent start-up	+
Low noise	—
Low friction	○
+ = Recommended    ○ = Suitable    — = Not suitable	

#### Available pack sizes LGGB 2

SYSTEM 24	
420 ml cartridge	5 kg can
18 kg can	180 kg drum





# Re-lubrication



## LGWM 1

### SKF extreme pressure low temperature bearing grease

LGWM 1 is a mineral oil based grease using a lithium soap and containing extreme pressure additives. It is extremely suitable for the lubrication of bearings operating under both radial and axial loads e.g. transport screws.

- Good oil film formation at low temperatures down to -30 °C (-22 °F)
- Good pumpability at low temperature
- Good corrosion protection
- Good water resistance

#### Typical applications:

- Windmills
- Screw conveyors
- Centralised lubrication systems
- Spherical roller thrust bearing applications



#### Bearing operating conditions

Temperature	Low to Medium
Speed	Low to Medium
Load	High
Vertical shaft	—
Fast outer ring rotation	—
Oscillating movements	+
Severe vibrations	—
Shock load or frequent start-up	+
Low noise	—
Low friction	—
Rust inhibiting properties	+

+ = Recommended    ○ = Suitable    — = Not suitable

#### Available pack sizes LGWM 1

420 ml cartridge	5 kg can
	180 kg drum
50 kg drum	

## LGWA 2

### SKF high load, extreme pressure, wide temperature range bearing grease

LGWA 2 is premium quality mineral oil based lithium complex grease with extreme pressure (EP) performance. LGWA 2 has such properties that it can be recommended for a wide range of industrial and automotive applications.

- Excellent lubrication at peak temperatures up to 220 °C (428 °F) for short periods
- Protection of wheel bearings operating under severe conditions
- Effective lubrication in wet conditions
- Good water and corrosion resistance
- Excellent lubrication under high loads and low speeds

#### Typical applications:

- Wheel bearings in cars, trailers and trucks
- Washing machines
- Electric motors



#### Bearing operating conditions

Temperature	Medium to High
Speed	Low to Medium
Load	High
Vertical shaft	○
Fast outer ring rotation	○
Oscillating movements	○
Severe vibrations	○
Shock load or frequent start-up	+
Low noise	—
Low friction	○
Rust inhibiting properties	+

+ = Recommended    ○ = Suitable    — = Not suitable

#### Available pack sizes LGWA 2

SYSTEM 24	35 g tube	200 g tube
420 ml cartridge	1 kg can	5 kg can
	50 kg drum	180 kg drum

## LGHB 2

### SKF high load, high temperature, high viscosity bearing grease

LGHB 2 is a premium quality, high viscosity, mineral oil based grease using the latest complex calcium, sulphonate soap technology. This grease contains no additives and the extreme pressure characteristics are created within the soap structure.



- Excellent anti-oxidation and anti-corrosion properties
- Good EP performance in applications running at high loads

#### Typical applications:

- Steel on steel plain bearings
- Pulp and paper making machines
- Asphalt vibrating screens
- Continuous casting machines
- Sealed spherical roller bearings operating up to 150 °C (302 °F)
- Withstands peak temperatures of 200 °C (392 °F)
- Work roll bearings in steel industry
- Mast rollers of fork lift trucks

#### Bearing operating conditions

Temperature	Medium to High
Speed	Very Low to Medium
Load	High to Very High
Vertical shaft	○
Fast outer ring rotation	+
Oscillating movements	+
Severe vibrations	+
Shock load or frequent start-up	+
Low noise	—
Low friction	—
Rust inhibiting properties	+

+ = Recommended    ○ = Suitable    — = Not suitable

#### Available pack sizes LGHB 2

SYSTEM 24		
420 ml cartridge		5 kg can
18 kg can	50 kg drum	180 kg drum

## LGHP 2

### SKF high performance, high temperature bearing grease

LGHP 2 is premium quality mineral oil based grease, using a modern Polyurea (di-urea) thickener. It is suitable for ball (and roller) bearings required to run extremely quiet, operating at a wide temperature range from -40 °C (-40 °F) up to 150 °C (302 °F), at medium to high speeds.



- Extremely long life at high temperature
- Wide temperature range
- Excellent corrosion protection
- High thermal stability
- Good low temperature start-up performance
- Compatibility with common Polyurea greases
- Compatibility with lithium complex thickened greases
- Low noise characteristics
- Very good mechanical stability

#### Typical applications:

- Electric motors: Small, medium and large
- Industrial fans, including high speed fans
- Water pumps
- Rolling bearings in textile, paper processing and drying machines
- Applications with high speed ball bearings operating at medium and high temperatures
- Clutch release bearings
- Kiln trucks and rollers
- Vertical shaft applications
- Vibrating applications

#### Bearing operating conditions

Temperature	Medium to High
Speed	Medium to High
Load	Low to Medium
Vertical shaft	+
Fast outer ring rotation	—
Oscillating movements	—
Severe vibrations	+
Shock load or frequent start-up	○
Low noise	+
Low friction	○

+ = Recommended    ○ = Suitable    — = Not suitable

#### Available pack sizes LGHP 2

SYSTEM 24		
420 ml cartridge	1 kg can	5 kg can
18 kg can	50 kg drum	



## Re-lubrication



### LGET 2

#### SKF extreme temperature, extreme condition bearing grease

LGET 2 is premium quality, synthetic fluorinated oil based grease using a PTFE thickener. It has excellent lubrication properties at extremely high temperatures exceeding 200 °C (392 °F) up to 260 °C (500 °F).

- Long life in aggressive environments such as very reactive environments or areas with a presence of high purity gaseous oxygen, hexane and so on
- Excellent oxidation resistance
- Good corrosion resistance
- Excellent water and steam resistance

#### Typical applications:

- Bakery equipment (ovens)
- Kiln truck wheels
- Load rollers in copying machines
- Wafer baking machines
- Textile dryers
- Film stretching tenders
- Electric motors running at extreme temperatures
- Emergency / hot fans
- Vacuum pumps



#### Bearing operating conditions

Temperature	Very High
Speed	Low to Medium
Load	High to Very High
Vertical shaft	○
Fast outer ring rotation	+
Oscillating movements	+
Severe vibrations	○
Shock load or frequent start-up	○
Low noise	—
Low friction	—
Rust inhibiting properties	○
+ = Recommended    ○ = Suitable    — = Not suitable	

#### Available pack sizes LGET 2

50 g (25 ml) syringe    1 kg can

*Important note: Fluorinated greases in general are very costly, however the SKF LGET 2 is competitively priced. Given that LGET 2 is more expensive than other SKF greases, it is therefore recommended to use it only for applications where other SKF greases would not provide the required performance.*

## Single-point automatic lubricators LAGD series

### More reliable and easier to use SYSTEM 24®

NEW

Poor lubrication can considerably reduce the service life of the best of bearings. With that in mind, SKF has enhanced the performance of the single-point automatic lubricator:

#### Product enhancements

Increased reliability at high temperatures as a result of:

- Transparent lubricant container made of polyamide reduces gas diffusion
- The larger molecules of the driving inert gas are less sensitive to higher temperatures

#### Intrinsically safe approval for Zone 0:

- Tested and approved for use in areas where an explosive atmosphere caused by gases, vapours and dust, is continuously present as well as for use in mines and underground areas.

#### Easy-to-remove end-cap:

- Covers the lubricant outlet; sharp tools are no longer required to open the outlet

SYSTEM 24. The lubricator's increased reliability and ease-of-use are a result of the following:

#### Easy installation:

- The tool-free activation and time setting slot allows easy and accurate adjustment of lubrication flow

#### Easy and quick fitting:

- Facilitated by easy-grip top cover



## SKF single point automatic lubricators LAGD 125 and LAGD 60

While enhancing the reliability and ease-of-use, SYSTEM 24 still offers you the features and benefits you have to come to expect from SKF automatic lubricators.

### Existing features

- Flexible time setting period ranging between 1 and 12 months
- High reliability and dispense rate accuracy allow fit and forget procedure until predetermined replacement date
- Transparent lubricant container allows visual inspection of dispense rate
- High capacity, compact size permits installation in restricted areas
- Redesigned non-return valve of the oil-filled SYSTEM 24 is less sensitive to vibration, minimising the risk of leakage
- Available filled with various high quality SKF greases and oils, which are especially developed for a wide range of bearing applications
- Dispense rate setting is a simple part of the installation process
- Hermetic sealing prevents ingress of dirt or foreign matter
- Allows low grease dispense rate
- Available in two sizes: 125 ml (LAGD 125) and 60 ml (LAGD 60)
- Can be temporarily deactivated
- Wide range of accessories is available
- II 1GD EEx ia IIC T6 T85°C  
I M1 EEx ia I  
EC Type Examination Certificate Kema04ATEX1275X

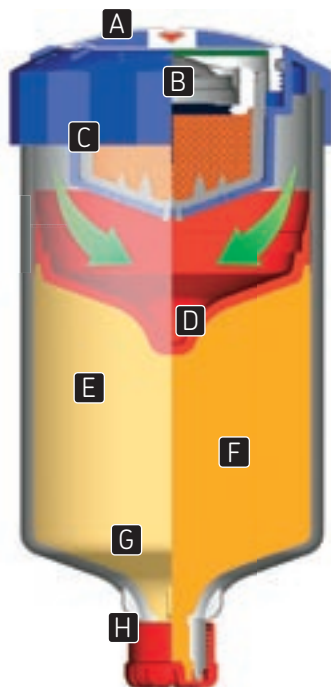

#### **A** Tool-free activation and time setting slot

Allows easy installation and accurate adjustment of lubrication flow

#### **B** Gas cell

Produces a large molecule inert gas, which is less temperature sensitive

#### **C** Easy-grip top-cover

Facilitates easy and quick fitting

#### **D** Special piston shape

Helps ensure optimum emptying of lubricator

SYSTEM 24® is a registered trademark of SKF USA Inc.

#### **E** Transparent container made of polyamide

Reduces gas diffusion and increases reliability

#### **F** High quality SKF bearing grease

SKF bearing greases, especially developed for bearing applications

#### **G** One-piece lubricant container with an integrated base

Offers better vibration resistance

#### **H** Removable lubricant outlet end-cap

No sharp tool is required to open the outlet



# Re-lubrication



## Ordering details

Designation	Description
LAGD 125/WA2	125 ml (4,25 fl oz. US) unit filled with LGWA 2 grease
LAGD 60/WA2	60 ml (2,03 fl oz. US) unit filled with LGWA 2 grease
LAGD 125/EM2	125 ml (4,25 fl oz. US) unit filled with LGEM 2 grease
LAGD 125/FP2	125 ml (4,25 fl oz. US) unit filled with LGFP 2 grease
LAGD 125/GB2	125 ml (4,25 fl oz. US) unit filled with LGGB 2 grease
LAGD 125/HB2	125 ml (4,25 fl oz. US) unit filled with LGHB 2 grease
LAGD 125/HP2	125 ml (4,25 fl oz. US) unit filled with LGHP 2 grease
LAGD 125/HFP15*	125 ml (4,25 fl oz. US) unit filled with food processing oil (viscosity ISO 150)
LAGD 125/HHT26*	125 ml (4,25 fl oz. US) unit filled with synthetic high temperature chain oil (viscosity ISO 265)
LAGD 125/HMT68*	125 ml (4,25 fl oz. US) unit filled with mineral EP type chain oil (viscosity ISO 68)
LAGD 60/HMT68*	60 ml (2,03 fl oz. US) unit filled with mineral EP type chain oil (viscosity ISO 68)
LAGD 125/U*	125 ml (4,25 fl oz. US) empty unit suitable for oil filling

\* Includes non-return valve

## Accessories ordering details

Designation	Description	Designation	Description
LAPA 45	Angle connection 45°	LAPM 2	Y-connection
LAPA 90	Angle connection 90°	LAPM 4	Manifold (4 to 1)
LAPB 3x4E1*	Brush 30 × 40 mm	LAPN 1/8	Nipple G 1/4 – G 1/8
LAPB 3x7E1*	Brush 30 × 60 mm	LAPN 1/2	Nipple G 1/4 – G 1/2
LAPB 3x10E1*	Brush 30 × 100 mm	LAPN1/4	Nipple G 1/4 – G 1/4
LAPB 5-16E*	Elevator brush, 5 – 16 mm gap	LAPN 3/8	Nipple G 1/4 – G 3/8
LAPB D2*	Brush round Ø 20 mm	LAPN 6	Nipple G 1/4 – M6
LAPC 50	Clamp	LAPN 8	Nipple G 1/4 – M8 × 1,25
LAPE 35	Extension 35 mm	LAPN 8x1	Nipple G 1/4 – M8 × 1
LAPE 50	Extension 50 mm	LAPN 10	Nipple G 1/4 – M10 × 1,5
LAPT 1000	Flexible tube, 1 000 mm long, 8 × 6 mm	LAPN 10x1	Nipple G 1/4 – M10 × 1
LAPF F1/4	Tube connection female G 1/4	LAPN 12	Nipple G 1/4 – M12
LAPF M1/4	Tube connection male G 1/4	LAPN 12x1.5	Nipple G 1/4 – M12 × 1,5
LAPF M1/8	Tube connection male G 1/8	LAPP 2E	Protection base
LAPF M3/8	Tube connection male G 3/8	LAPP 3E	Protection cover
LAPG 1/4	Grease nipple G 1/4	LAPV 1/4	Non return valve G 1/4
		LAPV 1/8	Non return valve G 1/8

\* Suitable for use with oil filled SYSTEM 24 units only



# SKF Chain oil range

## Extending chain life

SKF chain oils come in three convenient sizes to suit the needs of most chain applications in industrial environments. The chain oils, medium temperature, high temperature, and food compatible (NSF H1), are available in 400 ml (13,52 oz.) aerosol cans, 5 litre (1,32 gallon) cans, and as an oil fill for the SYSTEM 24 single point automatic lubricator.



**NEW**

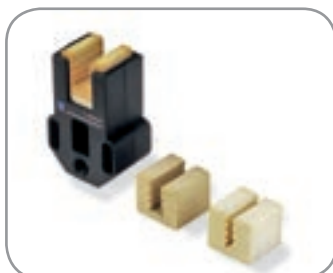

### Ordering details

Designation	Description
LHFP 150/0.4	400 ml (13,52 oz.) aerosol can
LHFP 150/5	5 litre (1,32 gallon) can
LAGD 125/HFP15*	125 ml (4,25 fl oz. US) SYSTEM 24 unit filled with food processing oil (viscosity ISO 150)
LHHT 265/0.4	400 ml (13,52 oz.) aerosol can
LHHT 265/5	5 litre (1,32 gallon) can
LAGD 125/HHT26*	125 ml (4,25 fl oz. US) SYSTEM 24 unit filled with synthetic high temperature chain oil (viscosity ISO 265)
LHMT 68/0.4	400 ml (13,52 oz.) aerosol can
LHMT 68/5	5 litre (1,32 gallon) can
LAGD 125/HMT68*	125 ml (4,25 fl oz. US) SYSTEM 24 unit filled with mineral EP type chain oil (viscosity ISO 68)
LAGD 60/HMT68*	60 ml (2,03 fl oz. US) SYSTEM 24 unit filled with mineral EP type chain oil (viscosity ISO 68)

\* Includes non-return valve



## Re-lubrication calculation program DialSet 3.0

### Accurate calculation of re-lubrication intervals

DialSet is a calculation program, which easily calculates the correct re-lubrication intervals settings. After selecting the criteria and grease relevant to your application, the program

provides you with the correct settings for your SKF automatic lubricators. Additionally, it recommends when to use LAGD 60, LAGD 125 (SYSTEM 24) or LAGD 400 (SYSTEM MultiPoint).

- Selecting the operating conditions of your application, vertical shaft, outer ring rotation and shock loads, allows accurate calculation of the re-lubrication intervals
- Calculations are based on the latest SKF lubrication theories published in the 2003 SKF General Catalogue (publ. nr. 5000)
- Calculated lubrication interval depends on the properties of the selected grease, minimising the risk of under or over-lubrication and optimising grease consumption
- Calculations are based on SYSTEM 24 and SYSTEM MultiPoint grease dispense rates, allowing the recommendation of the correct automatic lubricator for your application
- Recommended grease quantity depends on the grease replenishment position; side or W33 for optimum grease consumption
- Includes a complete list of SYSTEM 24 accessories



### DialSet 3.0 for PDA/PPC

If you own a PDA or a PPC, you can now calculate the correct re-lubrication intervals on-site. From [www.mapro.skf.com](http://www.mapro.skf.com) you can now download, free-of-charge, the PDA/PPC version of SKF's re-lubrication calculation program DialSet 3.0 in English language.

### DialSet 3.0 on CD-ROM

DialSet 3.0 is available on CD-ROM with calculation in six languages: English, French, German, Italian, Spanish and Swedish. The program is suitable for PC's working with MS Windows 98 or later and can be ordered from SKF under designation MP3506.

### DialSet 3.0 online

In addition to the downloadable PDA/PPC and the CD-ROM versions, SKF also offers you DialSet 3.0 online in English language. The program is accessible free-of-charge from [www.mapro.skf.com](http://www.mapro.skf.com). After filling in your application's conditions, calculations are made online and the program provides you with a printable re-lubrication interval recommendation.



# SYSTEM MultiPoint automatic lubricator LAGD 400

## Multiple grease lubrication points made easy

The lubrication of bearings with the correct type and quantity of grease is essential for trouble-free operation. Research has shown that 36% of all bearings fail prematurely due to incorrect lubrication. Especially for installations with multiple lubrication points, this can be a time-consuming and costly process. SYSTEM MultiPoint, SKF's centralised automatic lubricator, is the most user-friendly and cost-effective automatic lubricator for multiple grease lubrication points available today. Its compact design, combined with electronically controlled accuracy, makes it an excellent solution for longer bearing-life and increased uptime of your machinery.

Being a do-it-yourself lubrication system, SYSTEM MultiPoint can be easily installed without the assistance of a costly lubrication service company and requires no special training to use. Once the correct grease dispense rate for your application is calculated using DialSet 3.0, SKF's re-lubrication calculation program, SYSTEM MultiPoint will keep up to eight lubrication points simultaneously and automatically lubricated, preventing both over and under-greasing. The transparent cartridge housing allows for easy inspection, while an electronic alarm will warn you when the grease cartridge is empty.

- Do-it-yourself centralised lubrication system
  - Up to 8 feed lines
  - Easy-to-use
  - DialSet 3.0 included: SKF's re-lubrication calculation program allowing accurate calculation of the correct re-lubrication intervals
  - Long feed lines (maximum up to 5 m / 16 ft)
  - Electronic setting and read-out of control parameters
  - Alarm function for blocked feed lines and empty cartridge
  - Machine steering (i.e. lubricator only operates while machine is running)
  - High-pressure capability (40 bar / 600 psi)
  - Tested and approved with all SKF greases
  - Uses standard SKF grease cartridges (420 ml)
- Ready for use, all accessories included

127 

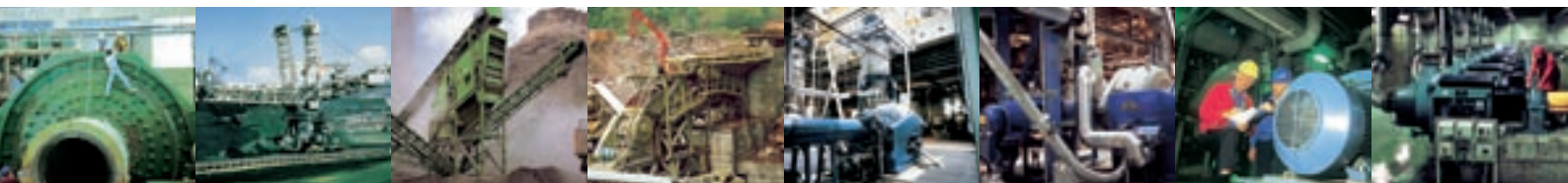





## Oil leveller LAHD series

### Automatic adjustment for optimal oil lubrication level

SKF Oil Levellers, LAHD 500 and LAHD 1000, are designed for automatic adjustment of the optimal oil lubrication level within a bearing housing, gear box, crank case or similar oil bath lubrication application. Not usually possible, SKF Oil Levellers allow you to effectively adjust the correct oil level during

running conditions, optimising machine performance and increasing the service life of the applications. Furthermore, they automatically compensate for oil leakage and offer the possibility of visual inspection of the oil level.

#### How it works

The SKF Oil Leveller consists of two communicating oil reservoirs. The lower reservoir is in direct contact with the application and hence its oil level is the same as the oil level inside the application. Through a ventilation hole, the lower reservoir is also in direct contact with the ambient air. The upper reservoir is an airtight container storing replacement oil. Through its extended neck, which dips into the oil of the lower reservoir, the two reservoirs are in direct contact with each other. However, oil can only flow from the upper to the lower reservoir once the oil level in the lower reservoir goes below the pre-set level, allowing air to flow through the extended neck to the upper reservoir.

- Optimally maintained oil level provides adequate lubrication
- Easy visual inspection
- Extended re-lubrication intervals. LAHD 1000 compensates for evaporation losses of up to 1 litre of lubricating oil!
- Oil must be refilled manually



## Grease packer LAGP 400

### To lubricate open bearings

The grease packer LAGP 400 is a low-pressure alternative for emptying SKF grease cartridges. It provides an easy and clean alternative to manual grease packing of open bearings.

- Supplied with three spout caps
- Applies grease to open plications such as bearings or open gears



# Grease gun 1077600

## Easy grease filling

The SKF grease gun is ideal for the agricultural, industrial and construction industries and for private use. The SKF grease gun is delivered with a 175 mm (6,9 in) long extension pipe with hydraulic gripping nozzle. A flexible 500 mm (19,7 in) long pressure hose with hydraulic gripping nozzle is available as an accessory.

- For use with cartridges and loose grease
- Rigid hinging system offers long-lasting use
- Knurled body for firm and safe grip
- High quality steel is dent-resistant for easy cartridge loading
- Special piston design for smooth emptying of cartridges
- 40 MPa (5 800 psi) maximum pressure
- 1,5 cm<sup>3</sup> (0,092 in<sup>3</sup>) volume/stroke
- Also available with a 300 mm (12 inch) high pressure hose with a hydraulic gripping nozzle, 1077600H
- A complete set, including 3 extension pipes, high pressure hose, packed in a carrying case is also supplied



### Ordering details

#### Designation

1077600  
1077600H  
1077601  
1077600/SET

#### Description

Grease gun with extension pipe  
Grease gun with flexible hose  
Flexible hose  
Grease gun set

# One hand operated grease gun LAGH 400

## Easy grease filling with one hand

Suitable for grease filling by grease filler pumps and also suitable for grease cartridges. Ergonomic design, flexible hose and possibility to mount the hose in both vertical and horizontal position make it easy to use.

- Easy-to-use: only one hand is needed to operate the gun
- Refillable: grease filling nipple and de-airing valve allow filling up by filler or grease pump
- Heavy duty: operating pressure up to 30 MPa
- 0,8 cm<sup>3</sup> (0,05 in<sup>3</sup>) volume/stroke
- Flexible hydraulic type hose: can be bent, can be mounted both horizontally and vertically on the gun





## Bearing packer VKN 550

### Contamination free grease filling

The SKF bearing packer, VKN 550, is a sturdy, easy-to-use, efficient and effective bearing grease packer. It can also be used in combination with a standard grease gun, air-operated grease pump or grease filler pump. Although specially designed for taper roller bearings, the SKF bearing packer works for any type of open bearing which needs to be 100 % pre-filled with grease.

- Flushes the grease between the rolling elements where it matters most, prolonging the bearing service life
- Closed system and the cover lid prevent ingress of dirt virtually eliminating contamination
- Allows the operator to pre-fill bearings with grease in a quick and clean way
- Prevents unnecessary grease loss
- Economical and environmentally friendly



## Disposable grease resistant gloves TMBA G11D

### Skin protection when handling grease

Specially designed to protect the skin when working with SKF bearing grease. The gloves are packed in a handy box containing 50 pairs.

- Non-powdered nitrile rubber gloves
- Close fitting for precision wear
- Excellent resistance against bearing greases
- Non-allergic



## Grease meter LAGM 1000E

### Accurate grease quantity measurement for adequate lubrication

It is generally difficult to determine the correct quantity of grease when manually lubricating bearings, either using a grease gun or pump, which can result in either over- or under-greasing the bearing. That can negatively influence the bearing's service life and possibly result in machine breakdown.

The SKF grease meter LAGM 1000E accurately measures grease discharge in volume or weight, in both metric (cm<sup>3</sup> or g) and US units (US fl. oz or oz). It has a high maximum pressure of 70 MPa (10 000 psi), making it ideal for use in combination with many types of grease guns and pumps.

- Measures grease discharge in volume or weight, making conversion calculations unnecessary
- High accuracy facilitates adequate bearing lubrication, reducing the risk of over- or under-greasing
- Suitable for all SKF bearing greases of consistency classes up to NLGI 3
- An oil and grease resistant rubber sleeve protects the electronics in case of impact
- The backlit LCD displays large and clear-to-read digits, including "low battery" indication
- Small, compact and lightweight design – only 0,3 kg (0,66 lb)
- Corrosion-free aluminium housing
- Easy to install and use



## Grease filler pumps LAGF series

### High quantity grease packer

SKF filler pumps are suitable for filling grease guns. Especially designed for use on grease gun 1077600 and LAGH 400. Tested and approved for SKF greases. Easy to install and ready for use. Available for standard SKF 18 and 50 kg (39 and 110 lb) drums.

- Quick filling: low pressure allows higher stroke volume
- Easy to install: all necessary items are included
- Reliable: tested and approved for all SKF greases
- Can be used in combination with SKF bearing packer VKN 550



#### Ordering details

Designation	Description
LAGF 18	Grease filler pump for 18 kg drums
LAGF 50	Grease filler pump for 50 kg drums

## Grease pumps LAGG series

### Meeting all your grease lubricator needs

Full range of manual and air-operated grease pumps are designed to empty standard 18, 50 or 180 kg (39, 110 or 400 lb) grease drums. Can be connected directly on the greasing points, also suitable for centralised lubricating grease systems.

- Full range; pumps available for 18, 50 or 180 kg (39, 110 or 400 lb) drums
- High pressure; maximum of 42 MPa (6 090 psi)
- Easy to install; all necessary items as well as 3 500 mm (137,8 in) of tubing are included
- Reliable; tested and approved for SKF greases
- Can be used in combination with SKF bearing packer VKN 550



SKF grease pumps have a maximum pressure of 40 and 42 MPa (5 800 and 6 090 psi) respectively. Tested and approved for SKF greases. Easy to install and ready for use since pumps are supplied with all necessary items including 3 500 mm (137,8 in) of tubing.

#### Ordering details

Designation	Description
LAGG 18M	Grease pump for 18 kg drums
LAGG 18AE	Mobile grease pump for 18 kg drums
LAGG 50AE	Grease pump for 50 kg drums
LAGG 180AE	Grease pump for 180 kg drums
LAGT 180	Trolley for drums up to 200 kg





## 1 kg grease pump LAGG 1M

### Contamination-free grease lubrication

The manual grease pump LAGG 1M facilitates clean and easy grease lubrication of bearings. The pump has been especially designed for use in combination with SKF 1 kg grease cans. It seals the grease can,

minimising grease contamination and slowing down the oxidation process. The LAGG 1M is suitable for use with greases of consistency classes ranging from 1 up to 3 NLGI.

- Airtight seal of the grease can, which slows down the oxidation process
- Greatly minimises the risk of grease contamination when compared to lubrication by operator's hand out of the grease can
- The pump is equipped with a locking mechanism
- The design of the pump helps ensure that virtually no residual grease remains in the can, making it economic to use and environmentally friendly
- Minimises user skin contact with the grease, which reduces the possibility of an allergic reaction to petroleum-based products
- Tested and approved for use with all SKF bearing greases
- Sturdy design for long service life



## Lubrication accessory sets

### Grease nozzles LAGS 8 / Grease nipples LAGN 120

#### The right tools for adequate (re)lubrication

The SKF LAGS 8 Grease nozzle kit provides the user with practical accessories for daily lubrication such as connectors, couplings and nozzles most widely used in the industry.

To meet all of your needs for grease lubrication points, SKF has developed a grease fitting kit, LAGN 120,

which contains a full range of 120 standardised conical grease fittings made of precision steel, zinc plated, hardened and blue chromated.

- Includes the most widely used accessories in the industry
- Upgrade the 1077600 grease gun with the LAGS 8 Grease nozzle kit
- Replace damaged grease fittings

#### Contents

Designation **LAGS 8**

Straight pipe 180 mm and nozzle / Hose / Tube / Tube with nose piece and plastic transparent cover / Nipple M10x1-G1/8 / Nipple M10x1-1/8-27NPS / Nozzle (2x)

#### Contents

Designation: **LAGN 120**

Grease nipple

Quantity

M6x1	straight	30x
M8x1	straight	20x
M10x1	straight	10x
G 1/8	straight	10x
M6x1	45°	5x
M8x1	45°	10x
M10x1	45°	5x
G1/8	45°	5x
M6x1	90°	5x
M8x1	90°	10x
M10x1	90°	5x
G1/8	90°	5x





# Basic Condition Monitoring

<b>Basic condition monitoring is essential for achieving maximum bearing service life</b>	78
General-purpose thermometer ThermoPen TMTP 200	79
Intrinsically safe ThermoPen TMTP 200Ex	79
Thermal imager TMTI 300	80
Non-contact thermometer ThermoLaser TMTL 500	81
Infrared Thermometer CMAC 4200-SL	81
Advanced infrared and contact thermometer Thermometer TMTL 1400K	82
K-type thermocouple probes TMDT 2 series	82
Multi-functional laser / contact tachometers TMRT series	84
Stroboscope TMRS 1	85
Endoscope TMES 1	86
Electronic stethoscope TMST 2	87
OilCheck monitor TMEH 1	87
Inspector 400 ultrasonic probe CMIN 400-K	88
Vibration Pen <sup>plus</sup> CMVP series	88
Basic condition monitoring package CMPK series	89
Bearing analysis kit CMPK series	89
MicroVibe P CMVL 3850	90
MARLIN <sup>®</sup> condition detector pro IS CMVL 3600-IS	90



## Basic Condition Monitoring

# Basic condition monitoring is essential for achieving maximum bearing service life

To help ensure long bearing service life, it is important to determine the condition of machinery and bearings while in operation. Good predictive maintenance will help reduce machine downtime and decrease overall maintenance costs. To help you achieve the maximum service life from your bearings, SKF has developed a wide range of measuring instruments for analysing the critical environmental conditions, which have an impact on bearing and machine performance.

The SKF range covers the most important parameters for measuring machine condition to achieve optimum bearing performance:

- Temperature
- Speed
- Noise
- Oil condition
- Vibrations
- Bearing condition

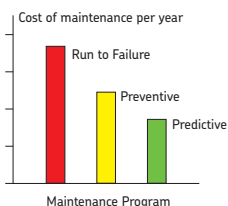

A



*The most expensive maintenance alternative. Maintenance cost comparisons.*



B



*Preventive maintenance is similar to the regular service of a car. Often unnecessary maintenance is performed.*

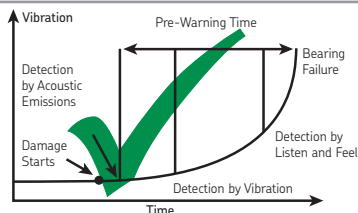

C

*Condition based maintenance means repairs are only carried out when required. The most effective alternative.*

### Maintenance Concepts

#### A Run to failure

Run to failure occurs when repair action is not taken until a problem results in machine failure. Run to failure problems often cause costly secondary damage along with unplanned downtime and maintenance costs.

#### B Preventive maintenance

Preventive maintenance implies that a machine, or parts of a machine, are overhauled on a regular basis regardless of the condition of the parts. While preferable to run to failure maintenance, preventive maintenance is costly because of excessive downtime from unnecessary overhauls and the cost of replacing good parts along with worn parts.

#### C Predictive maintenance

Condition monitoring/predictive maintenance is the process of determining the condition of machinery while in operation. This enables the repair of problem components prior to failure. Condition monitoring not only helps plant personnel reduce the possibility of catastrophic failure, but also allows them to order parts in advance, schedule manpower, and plan other repairs during the downtime.

With condition monitoring, machinery analysis takes two overlapping forms: predictive and diagnostic.

## General-purpose thermometer ThermoPen TMTP 200

### Accurate temperature measurement in general industries

The SKF ThermoPen is a user-friendly, durable pocket size thermometer. Its sturdy flexible probe tip provides effective surface contact for accurate temperature measurement. Since no maintenance engineer should work without one, the ThermoPen is supplied with a handy pouch with belt clip for protection and portability.

- Compact, ergonomic design
- Wide measurement range, from  $-40$  to  $200$  °C ( $-40$  to  $392$  °F)
- Temperature reading selection in °C or °F
- Flexible probe tip for better surface contact, providing high measuring accuracy
- Dust tight and water resistant, rated IP 65
- Maximum temperature function allows temperature peak hold
- Auto power off function
- Ultra low power consumption



## Intrinsically Safe ThermoPen TMTP 200Ex

### Safe and accurate temperature measurement in explosive hazardous areas

The SKF ThermoPen is also available in an intrinsically safe (Ex) version, especially designed for use in explosive hazardous areas. The Intrinsically Safe ThermoPen has been tested and approved for use in high-risk areas, such as:

- Underground and surface mining operations
- Areas where explosive atmospheres caused by mixtures of air and gasses, vapours or mists are present
- Areas where explosive atmosphere caused by a mixture of air and dust is present
- Intrinsically safe; one of few thermometers approved for use in the highest risk areas
- Certified confirming to ATEX, EC type examination ISSEP02ATEX054X
- Approvals: Mining I M1 EEx ia I  
Other areas II 1GD EEx ia IIC T4 IP65







# Basic Condition Monitoring

## Thermal imager TMTI 300

Thermal imaging for effective maintenance is now affordable



The SKF TMTI 300 is a flexible, easy-to-use thermal imager that produces visible images from invisible infrared radiation. It enables effective viewing of a wide range of temperatures for safe inspection of mechanical and electrical machinery.

- Easy-to-use, light weight, one or two handed operation allows the TMTI 300 to be flexible and used for most industrial applications
- Non-contact measurement technique enables measurements to be made safely on running equipment
- Large thermal image storage capacity, 1 000 images per Mb can be stored on Pocket PC/storage card. Easy for data collection and subsequent reporting
- Two user defined spot temperature measurement points allow comparison of areas of interest. The temperature difference of the 2 spots is displayed as a separate value
- Both PC and "Pocket PC" compatible allowing flexibility in viewing results and report writing
- Software included for ease of data analysis
- Laser pointer shows the size of a pixel, allowing the area of interest to be pinpointed and for accurate measurement
- Convenient temperature measurement in K, °C and °F eliminates the necessity to convert temperature reading
- 3 different selectable colour pallets (green/blue, red/blue, greyscale) for ease of viewing
- Tripod mounting thread for stability and stable monitoring over a period of time
- Sturdy "ready use" carrying case. The imager, pistol grip and pocket PC can be stored as one assembly ready for use
- Ideal complement to other condition monitoring techniques, such as vibration analysis

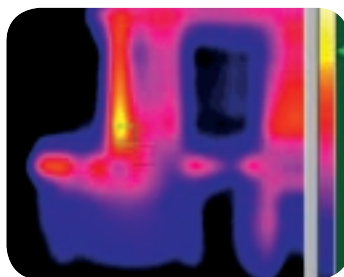
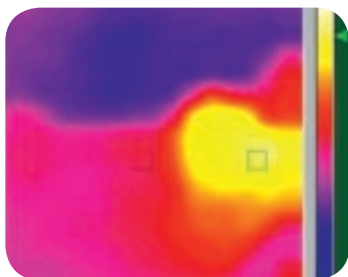

The TMTI 300 is used to show a difference in temperature between two running bearings. This temperature difference could indicate a potential bearing problem that could lead to a failure and downtime.

The TMTI 300 is used to inspect cable connections. The temperature of one of the cable connections is significantly higher than the others. This could indicate potential problems and should be further investigated.

## Non-contact thermometer ThermoLaser TMTL 500

NEW

### Measuring temperature at a safe distance

Lightweight and compact, the ThermoLaser utilises advanced class II laser beam for accurate aiming and an infrared detector for measuring temperature. The ThermoLaser is extremely user-friendly – simply aim, pull the trigger and read the temperature on the large backlit display. No contact with hot surfaces or moving parts means safer, faster and easier temperature measurement.

- Safely measures the temperature of hot, hazardous or hard-to-reach objects
- Wide measurement range from  $-60$  to  $500$  °C ( $-76$  to  $932$  °F)
- Distance/spot ratio of 11:1, better for applications where accuracy is critical
- Ideal complement to other condition monitoring techniques, such as vibration analysis
- Backlit display, making temperature easier to read in dimly lit or dark places
- Temperature reading selection in °C or °F
- Low power consumption using 2x AAA batteries, more energy efficient
- Auto shut off feature, to optimise battery life
- Robust construction for use in an industrial environment

Additionally, the ThermoLaser allows temperature measurement where contact with a conventional temperature probe should be avoided to prevent surface contamination, making ideal to use for measuring temperature of food processing applications.



## Infrared Thermometer CMAC 4200-SL

### Measuring wide temperature range at safe distance

The SKF Infrared Thermometer CMAC 4200-SL with laser sighting is a rugged, easy to use portable non-contact thermometer. Ideal for a broad range of maintenance tasks, the CMAC 4200-SL may be connected directly to SKF's portable data collectors for quick, accurate recording of temperatures.

- Wide temperature range of  $-30$  °C to  $900$  °C ( $-25$  to  $1\ 600$  °F)
- Accuracy  $\pm 1$  % of reading
- Compatible with SKF portable data collectors
- Designed for physically demanding environments
- Easy to use
- 16-Dot laser sighting circle with Distance to Spot size (D:S) of 60:1
- Adjustable emissivity with on-board table
- Fast response time

A useful on-board table including 30 pre-set material emissivity listings is easily accessed, allowing accurate temperature measurement of different material surfaces.





## Basic Condition Monitoring

### Advanced infrared and contact thermometer ThermoLaser TMTL 1400K

NEW

#### Versatility in temperature measurement

The TMTL 1400K combines the flexibility of an infrared thermometer with the facility of a contact thermometer. An object's temperature can be measured using an infrared detector or a probe, making it ideal for situations where accurate temperature measurement is necessary and the emissivity of an object is unknown. It is supplied with a K type probe, has variable emissivity, and many different possible measurement modes.

It offers solutions for a wide range of applications; such as checking the temperature on reflective surfaces like aluminium and bearings, checking temperature on moving parts and checking temperature where contact should not be made due to possible contamination.

- User selectable variable emissivity between 0.1 and 1.0, when used in conjunction with the probe the correct emissivity can be defined helping to ensure accurate temperature measurement
- The SKF temperature probe TMDT 2-30 is included (max. 900 °C/ 1652 °F), ideal for measuring objects with a high temperature
- Safely measures the temperature of hot, hazardous or hard-to-reach objects
- Wide measurement range using infrared sensor from -60 to 500 °C (-76 to 932 °F), with probe -64 to 1 400 °C (-83 to 1 999 °F)
- Distance/spot ratio of 11:1, better for applications where accuracy is critical
- Ideal complement to other condition monitoring techniques, such as vibration analysis
- Backlit display, making temperature easier to read in dimly lit or dark places
- Temperature reading selection in °C or °F
- Low power consumption using 2x AAA batteries, more energy efficient
- Auto shut off feature that can be programmed from 1 minute to 1 hour, to optimise battery life
- Robust construction for use in an industrial environment



132

### K-type thermocouple probes TMDT 2 series

#### Wide variety of thermocouple probes for many applications

SKF offers fifteen K-type thermocouple probes for use with the SKF digital thermometer TMDT 1300.

#### Typical applications are:







- Surface measurements (TMDT 2-30, -31, -32, -33)
- Gas and liquid measurements (TMDT 2-34)
- Semi solid materials (TMDT 2-35)
- Clamp for pipe measurements (TMDT 2-36)
- Rotating surface measurements (TMDT 2-40)
- Liquid non-ferrous metal measurements (TMDT 2-41)
- Ambient temperature measurements (TMDT 2-42)
- Gas measurements – wire probes (TMDT 2-38, -39)
- Heavy-duty surface measurements (TMDT 2-43)

*All probes can be used with the SKF digital thermometer TMDT 1300 without recalibration.*

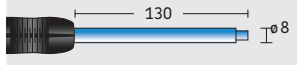

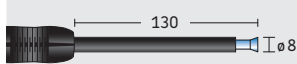
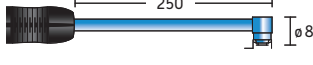
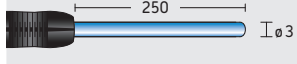
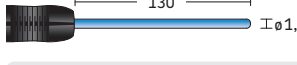
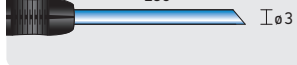
132

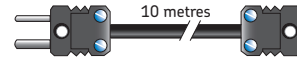
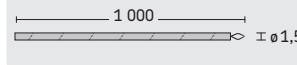
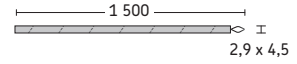
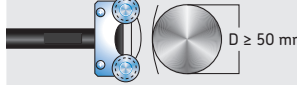
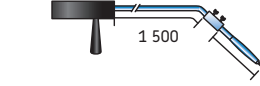
## K-type thermocouple probes

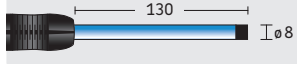
Designation	Description	Dimensions (mm)	Max. temp	Response time
TMDT 2-30	<b>Standard surface probe</b> For hard surfaces such as bearings, bearing housings, engine blocks, oven shields, etc.		900 °C 1 650 °F	2,3 sec
TMDT 2-31	<b>Magnetic surface probe</b> For hard, magnetic surfaces; the integral heat sink design and low mass minimise thermal inertia and provide an accurate temperature measurement.		240 °C 460 °F	7,0 sec.
TMDT 2-32	<b>Insulated surface probe</b> For hard surfaces where electrical wiring might cause short circuiting, e.g. electric motors, transformers, etc.		200 °C 390 °F	2,3 sec.
TMDT 2-33	<b>Right angle surface probe</b> For hard surfaces in heavy-duty applications, e.g. machine components, engines, etc.		450 °C 840 °F	8,0 sec.
TMDT 2-34	<b>Gas and liquid probe</b> Flexible shank made of stainless steel for liquids, oils, acids, etc. and at high temperature, e.g. open fire (not for molten metals).		1 100 °C 2 010 °F	12,0 sec.
TMDT 2-34/1.5	<b>Gas and liquid probe</b> Same as TMDT 2-34 but with thin shank and faster response time. Very flexible, specially suitable for measuring temperature of gases.		900 °C 1 650 °F	6,0 sec.
TMDT 2-35	<b>Probe with sharp tip</b> Can be easily inserted into semi-solid materials like food-stuffs, meat, plastic, asphalt, deep-frozen products, etc.		600 °C 1 110 °F	12,0 sec.
TMDT 2-35/1.5	<b>Probe with sharp tip</b> Same as TMDT 2-35 but with thinner shank and faster response time for insertion into soft solids.		600 °C 1 110 °F	6,0 sec.
TMDT 2-36	<b>Pipe clamp probe</b> For temperature measuring on pipes, cables, etc. Diameter up to ø 35 mm (1,4 in).		200 °C 390 °F	8,0 sec.
TMDT 2-37	<b>Extension cable</b> For use with all K-type probes. Special lengths are available on request.			
TMDT 2-38	<b>Wire probe</b> Thin, light weight, very fast response, fibreglass insulated.		300 °C 570 °F	5,0 sec.
TMDT 2-39	High temperature wire probe Thin, light weight, very fast response, ceramic insulation.		1 350 °C 2 460 °F	6,0 sec.
TMDT 2-40	<b>Rotating probe</b> For moving or rotating smooth surfaces. Four roller bearings provide suitable contact with the surfaces. Max. velocity 500 m/min.		200 °C 390 °F	0,6 sec.
TMDT 2-41	<b>Non-ferrous foundry probe</b> Holder including dip-element for molten, non-ferrous metals. Highly resistant to corrosion and oxidation at high temperatures.		1 260 °C 2 300 °F	30,0 sec.
TMDT 2-41A	<b>Dip-element</b> Replacement dip-element for TMDT 2-41.		1 260 °C 2 300 °F	30,0 sec.
TMDT 2-42	<b>Ambient temperature probe</b> For measurement of ambient temperature.			
TMDT 2-43	<b>Heavy duty surface probe</b> Same as TMDT 2-30 but with silicon encapsulated tip for heavy duty applications.		300 °C 570 °F	3,0 sec.



## Multi-functional laser / contact tachometers TMRT series

### Pinpoint accuracy combined with measurement versatility

The SKF TMRT series includes two user-friendly and accurate tachometers utilising laser or contact for measuring rotational and linear speed: TMRT 1 and TMRT 1Ex. Equipped with laser and contact adaptor, both tachometers offer excellent speed measurement versatility in five different modes.

Additionally, their large angular range of  $\pm 80^\circ$  to target facilitates the easy measurement in areas where straight-line access is difficult. The laser optical system allows easy and quick speed measurement at safe distance from rotating machinery.

### Intrinsically safe tachometer TMRT 1Ex

The SKF TMRT 1 is also available in an intrinsically safe (Ex) version, especially designed for use in potentially explosive hazardous areas. The TMRT 1Ex has been tested and certified according to the latest ATEX standards in intrinsic safety zones generally found in industries such as the petrochemical, gas and pharmaceutical among others. EC Type Examination Certificate Baseefa03ATEX0425X.

II 2 G EEx ia IIC T4

- The user can select to measure:
  - rpm, rps, m, ft or yds per minute or second,
  - length or revolution counting, or
  - time interval
- Wide speed range and the various measurement modes make the TMRT series suitable for measuring speed in many applications
- Large angular range of  $\pm 80^\circ$  to target facilitates easy measuring in areas where straight-line access is difficult
- The large inverting LCD display facilitates easy reading even when pointing the unit down into the machinery
- Compact design; one-hand operated instrument
- Supplied in carrying case for protection and portability
- The TMRT 1 can also be equipped with remote laser sensor, which is optionally available



# Stroboscope TMRS 1



## Easy, cost effective inspection in a flash

The SKF TMRS 1 is a portable, easy-to-use stroboscope that allows the motion of rotating or reciprocating machinery to appear frozen, facilitating inspection without stopping the machine.

- The bright flash allows better illumination of the application at a distance, giving a wider viewing area.
- Flash rates of up to 12 500 flashes per minute (FPM) cover a wide range of applications
- Flash rate is quick and easy to adjust using the variable dial rate. Allowing the required speed to be reached within a matter of seconds
- Phase shift mode for optimum inspection of gears, rolls, fans, pulleys. The feature of interest can be rotated to the correct position for inspection
- $\times 2$ ,  $\div 2$  buttons for quick adjustment of FPM
- Easy to read LCD display
- Compact design, one-hand operated instrument
- Battery powered with long running time per charge (up to 2,5 hrs)
- Includes universal AC adaptor that can be used worldwide
- Extra flashtube supplied to minimise downtime of unit
- Supplied in carrying case for protection and portability
- Mounting thread on the underside allows mounting on a tripod for stability and ease of use

Equipped with a phase shift feature that allows the user to advance or retard the flash timing without changing the flash rate, the motion can be “frozen” at the position required for inspection.





# Basic Condition Monitoring

## Endoscope TMES 1

Easy, cost effective inspection in restricted spaces



The SKF TMES 1 is a compact, lightweight endoscope that can be used for effective visual inspection even in the most restricted spaces. Equipped with a built-in variable light source

and a flexible 1 metre (3,3 ft) long fibre optic tube it is suited to most industrial applications.

- Compact, lightweight design makes the endoscope easily portable
- High quality optics allow good image resolution for diagnostic purposes
- Fully flexible 1 metre (3,3 ft) fibre optic tube with a 40 mm (1,6 in) bending radius allows use in applications with tight corners
- Water resistant flexible tube can be used in applications where moisture is present
- Built-in battery powered light source can be adjusted to help prevent over illumination
- Length of handle can be reduced for use in areas with limited space
- Straight view allows the image at the tip to be directly seen without having to make time-consuming adjustments
- 60° field of view offers an excellent viewing range for restricted space applications
- Easy to assemble and use, thus special training is not required
- Digital camera adaptor is available as an accessory in order to record results for report writing or sending image on for diagnostics

TMES 1 with optional digital camera adaptor. Camera not included



Not for medical applications

## Electronic stethoscope TMST 2

### Detects changes in bearing condition

The SKF TMST 2 is a high quality, sensitive instrument enabling the determination of troublesome machine parts by the detection of machine noises or vibrations. With the included headset, two different length probes, an adjustable sound level facility and a comparative pre-recorded demonstration CD, it is an ideal instrument for detecting troublesome machine parts or damaged bearings. The instrument, probes, headset and demonstration CD are supplied complete in a sturdy carrying case.

- User friendly
- Rugged construction
- Output for tape recording
- Pre-recorded demonstration CD for comparisons
- Equipped with piezo-electric sensor and adjustable volume control
- Sturdy sensitive headset
- Two probes as standard

it is an ideal instrument for detecting troublesome machine parts or damaged bearings. The instrument, probes, headset and demonstration CD are supplied complete in a sturdy carrying case.

134 



## OilCheck monitor TMEH 1

### Detects changes in oil condition

The OilCheck measures the changes in dielectric constant of an oil. By comparing the measurements obtained from used and unused oils of the same type and brand, the SKF OilCheck is able to determine the degree of change in the condition of the oil. Dielectric change is directly related to the degradation

and the contamination level of the oil and will allow the user to achieve optimised intervals between oil changes and detect increased mechanical wear and loss of the oils lubricating properties. To facilitate trending the instrument is equipped with a numerical read-out.

### Warning

The SKF OilCheck is not an analytical instrument. It is an instrument to detect only changes in the oil condition. The visual and numerical read-outs are purely a guide to enable trending of the comparative readings of a good oil to a used oil of the same type and brand. Do not rely solely on numerical readings.

- Shows changes in oil condition affected by such things as:
  - Water content
  - Fuel contamination
  - Metallic content
  - Oxidation
- Hand held and user friendly
- Numerical read-out to facilitate trending

134 







## Basic Condition Monitoring

### Inspector 400 ultrasonic probe CMIN 400-K

#### Easy detection of high frequency sounds

The Inspector 400 Ultrasonic Probe senses high frequency sounds produced by operating equipment, leaks and electrical discharges. It electronically translates these signals by a heterodyning process, making them audible,

so that a user can hear these sounds through a headset and see them as intensity increments on a meter.

- Detects pressure and vacuum leaks, including compressed air
- Checks steam traps and valves quickly and accurately
- Detects arcing, tracking and corona in electric apparatus
- Tests bearings, pumps, motors and compressors
- Frequency response: 20 - 100 kHz (centred at 38 - 42 kHz)
- Indicator: 10-segment LED bar graph (red)



### Vibration Pen<sup>plus</sup> CMVP 40 and CMVP 50

#### A powerful combination for detection of machine and bearing defects

A multi-parameter approach to condition monitoring provides two different methods for monitoring machinery condition. This allows early detection of specific machinery problems and provides more ways to measure changes in machinery condition. The Vibration Pen<sup>plus</sup> is a multi-parameter vibration-monitoring tool capable of measuring vibration caused by rotational and structural problems such as unbalance,

misalignment and looseness. It is also capable of measuring vibration in higher frequencies caused by rolling element bearing or gear mesh problems. This approach provides accurate and reliable data upon which to base maintenance decisions and promotes early detection, confirmation and accurate trending of bearing and machinery problems.

- Measures ISO 10816, low frequency vibration, from 10 Hz to 1 kHz, for overall machine condition
- Assess vibration in industrial non-reciprocating machinery
- Acceleration enveloping for early warning of bearing and gear mesh faults
- So light and compact it fits in your shirt pocket
- Easy one button operation
- Easy to read dual value display



#### Ordering details

Designation	Description
CMVP 40	(in/s) eq. peak – English Vibration Pen <sup>plus</sup>
CMVP 50	(mm/s) RMS – Metric Vibration Pen <sup>plus</sup>

# Basic condition monitoring package CMPK series

## Check bearing and machine condition quickly and easily

The CMPK series is an essential collection of monitoring tools that no industrial manufacturing plant should be without. These tools make condition monitoring a simple task for maintenance, operations, reliability and vibration analysis departments.



### Kit CMPK 200<sup>plus</sup> (Metric) includes:

- Vibration Pen<sup>plus</sup> with Carrying Case CMVP 50 (mm/s, RMS – Metric)
- Inspector 400 Ultrasonic Probe with Headphones CMIN 400
- Non-contact MicroTemp Thermometer CMSS 2020
- Batteries included
- VibCard
- Belt Holder for the Vibration Pen<sup>plus</sup>
- Comprehensive Quick Start Instruction Card
- Rugged Carrying Case

### Kit CMPK 210<sup>plus</sup> (English) includes:

- Vibration Pen<sup>plus</sup> with Carrying Case CMVP 40 (in/s, eq. peak – English)
- Remainder of items same as the CMPK 200<sup>plus</sup> package

# Bearing analysis kit CMPK series

## Check bearing and machine condition quickly and easily

The Bearing Analysis Kit is a convenient collection of monitoring tools that no industrial manufacturing plant should be without. It makes condition monitoring a simple task for maintenance, operations, reliability and vibration analysis departments.

### Bearing Analysis Kit CMPK 60<sup>plus</sup> (English) includes:

- Vibration Pen<sup>plus</sup> CMVP 40 (in/s, eq. peak – English), including manual, carrying case, severity card and battery
- Laser Sighted Non-Contact Temperature Probe CMSS 2000-SL, including manual, hard case, belt clip and battery
- OilCheck Monitor TMEH 1, including soft carrying case and battery
- Custom hard-shell carrying case

### Bearing Analysis Kit CMPK 70<sup>plus</sup> (Metric) includes:

- Vibration Pen<sup>plus</sup> CMVP 50 (mm/s, RMS – Metric), including manual, carrying case, severity card and battery
- Remainder of items same as the CMPK 60<sup>plus</sup> kit



Ordering details	
Designation	Description
CMPK 60 <sup>plus</sup>	Bearing Analysis Kit (English)
CMPK 70 <sup>plus</sup>	Bearing Analysis Kit (Metric)



# Basic Condition Monitoring

## MicroVibe P CMVL 3850

### Analysis power without complexity

This economical vibration meter expansion module fits in a Pocket PC's compact flash card slot (CF Type II) and features the user-friendly Windows Mobile Operating System. Identify problems and assess machine condition quickly and easily with this versatile and easy-to-use pocket tool.

- Universal PDA platform with user-friendly Windows™ Mobile OS
- Displays overall vibration, time—waveform, FFT spectrum analysis and early indication of bearing degradation
- Easily operated by novice and experienced users
- On-board vibration dictionary
- Enables experienced Pocket PC users to upload overall scalar and spectral data to PC for trending and further analysis with included Data Management Software
- Kit includes MicroVibe P Module, MicroVibe P Data Management Software, accelerometer and cable, stinger and magnet, earphones and carrying case (does not include PDA)

The MicroVibe P collects and displays overall vibration readings and automatically provides expert judgment of the measured velocity and overall enveloped acceleration levels, enabling immediate, accurate and reliable assessment of machine or bearing condition.



## MARLIN® condition detector pro IS CMVL 3600-IS

### Intrinsically safe automatic collection of vibration and temperature data

The MARLIN Condition Detector Pro IS (MCD) is certified as Intrinsically Safe (IS) for use in the hazardous environments typically found in the Petrochemical Industrial marketplace.

The sensor of the MARLIN Condition Detector Pro IS affixes to a machine point via a MARLIN QuickConnect (MQC) Stud or magnetic bases for automatic collection of vibration and temperature data. Green, yellow and red LEDs provide easy to interpret indications of equipment status, so operations or maintenance personnel can quickly identify the need for more in-depth analysis on a particular machine.

The MARLIN Condition Detector Pro IS operates as a stand-alone device, or as an integral component of the complete MARLIN System. By pairing the MARLIN Condition Detector Pro IS with the MARLIN data managers (MDM), important machinery and process information may be stored for trending review and detailed analysis.

- Vibration velocity and enveloped acceleration (gE), and temperature measurements
- Use with MARLIN, ODR data collectors or stand alone
- Red, Yellow, and Green LED alarms for quick go-no-go indication of equipment status
- Interfaces with the MARLIN QuickConnect (MQC) mechanical/computerized studs provides for a fast, quarter turn connection which temporarily fastens the probe to a measurement point
- Intrinsic Safety (IS): LCIE:
  - Approved to CENELEC EN50 020, EEX ia lic T4
  - CSA: Class I, Division 1, Groups A, B, C, D T3A (USA, Canada)





# Dismounting

## Bearing dismounting

### Mechanical dismounting

Guide to SKF puller selection	93
Guide to SKF puller accessory selection	94
TMMA pullers series: mechanical EasyPull	95
TMMA pullers series: hydraulic EasyPull	96
TMMA pullers series: hydraulic EasyPull set TMMA 8E/SET	96
Tri-section pulling plates TMMS series	97
Advanced hydraulic spindles TMHS 75 and TMHS 100	97
Standard jaw pullers TMMP series	98
Reversible jaw pullers TMMR F series	99
Heavy duty jaw pullers TMMP series	99
Hydraulically-assisted heavy duty jaw pullers TMHP series	100
Hydraulic jaw puller kit TMHP 10E	100
Hydraulic puller kit TMHC 110E	101
Strong back pullers TMBS E series	101
Deep groove ball bearing puller kit TMMD 100	102
Internal bearing puller kits TMSC series	103
Puller protection blankets TMMX series	104
Blind housing puller kit TMBP 20E	105
Other dismounting tools	105

### Dismounting using heat

Aluminium heating rings TMBR series	106
Adjustable induction heaters EAZ series	106
Fixed induction heaters EAZ series	107

### Dismounting bearings using hydraulic techniques

SKF Oil injection method	108
Hydraulic nuts HMV ..E series	108
Dismounting fluid	109
Hydraulic pumps and oil injectors selection guide	110



# Bearing dismounting

## Reduce the risk of damaging components and personal injury

When dismounting bearings, care must be taken not to damage other machine components, such as the shaft or housing, as damage can result in compromising the machine's efficiency and lifetime. Bearings are sometimes dismantled to maintain or replace other components of the machine. These bearings are often re-used. Selecting the correct dismounting methods and tools is then essential in reducing the risk of damaging the bearing, allowing it to be used again. Dismounting bearings can be a hazardous and demanding task. Selecting the correct dismounting methods and tools is therefore of utmost importance for reducing the risk of personal injuries. Individual applications may require mechanical, heat or hydraulic dismounting methods and tools to allow safe, correct and efficient bearing dismounting.

## Mechanical dismounting

Choosing the right puller for the job is critical. Not only the puller type, but also its maximum withdrawal capacity is crucial for completing any dismounting job safely and easily. Puller overload can result in breakage of the puller's arms and/or beam and therefore should be avoided. This breakage can damage the bearing or shaft and can cause personal injury. In general, it is recommended to use a three-arm puller rather than a two-arm one as the three-arm puller is more stable. Whenever possible, apply the withdrawal force to the ring with the interference fit. SKF offers a complete range of easy-to-use mechanical, hydraulic and hydraulically assisted bearing pullers for use in many bearing applications.

## Dismounting using heat

The inner rings of cylindrical roller bearings generally have a tight interference fit, which requires high forces to dismount. In such cases, using a puller can cause damage to the shaft and ring, and can be hazardous to the operator. Using heating equipment facilitates easy and quick dismounting while reducing the risk of damage to the ring and shaft. SKF offers a range of heating equipment, which includes aluminium heating rings as well as adjustable and fixed induction heaters, for dismounting cylindrical roller bearing inner rings.

## Dismounting bearings using hydraulic techniques

The SKF hydraulic techniques are often the preferred method for dismounting larger bearings as well as other components. These techniques, which employ hydraulic pumps, nuts and oil injectors, allow the application of substantial forces to dismount bearings or other components.

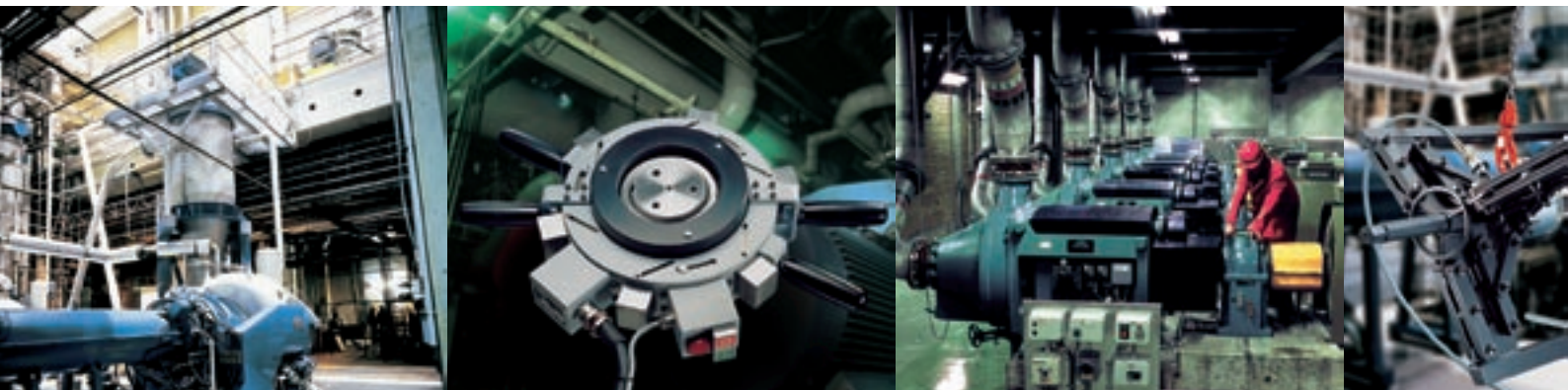

## Safety

For optimum safety when dismantling bearings:

- Always wear protective clothing and goggles when dismantling bearings
- When dismantling bearings using pullers, make sure to select a suitable puller for the application with sufficient pulling force in order to reduce the risk of puller overload. Overloading a puller can result in puller arm or spindle breakage, causing injury to the operator
- A safety blanket fitted around the puller and bearing helps reduce the risk of injury in case the bearing, puller's arm or spindle break
- Always use heat resistant gloves when dismantling bearings using heat
- For your own safety, do not strike the bearing directly with any hard object such as a hammer or chisel
- Apply dismantling force to part of bearing that has highest fit

# Mechanical dismantling

## Always the right puller for the job

SKF offers a wide range of bearing pullers for various types of pulls: External, internal and even blind. The range includes mechanical, hydraulic and hydraulically assisted pullers for easy application of high withdrawal forces.





# Dismounting

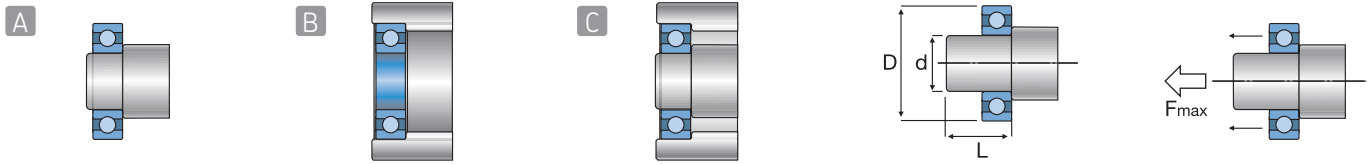

## Guide to SKF puller selection

Type of pull	Designation	No. of arms	Width of grip		Effective arm length		Maximum withdrawal force			
			D	D	L	L	F max	F max		
			mm	in	mm	in	kN	ton (US)		
<b>EXTERNAL PULL</b>	TMMP 2x65	2	15 – 65	0,6 – 2,6	60	2,4	6	0,7		
	TMMP 2x170	2	25 – 170	1,0 – 6,7	135	5,3	18	2,0		
	TMMP 3x185	3	40 – 185	1,6 – 7,3	135	5,3	24	2,7		
	TMMP 3x230	3	40 – 230	1,6 – 9,0	210	8,3	34	3,8		
	TMMP 3x300	3	45 – 300	1,8 – 11,8	240	9,4	50	5,6		
	TMMP 6	3	50 – 127	2,0 – 5,0	120	4,7	60	6,7		
	TMMP 10	3	100 – 223	3,9 – 8,7	207	8,2	100	11,2		
	TMMP 15	3	140 – 326	5,5 – 12,8	340	13,4	150	17,0		
	TMMA 60	3	36 – 150	1,4 – 5,9	150	5,9	60	6,7		
	TMMA 75H	3	52 – 200	2,0 – 7,8	200	7,8	75	8,4		
	TMMA 80	3	52 – 200	2,0 – 7,8	200	7,8	80	9,0		
	TMMA 100H + .../SET	3	75 – 250	3,0 – 9,8	250	9,8	100	11,2		
	TMMA 120	3	75 – 250	3,0 – 9,8	250	9,8	120	13,5		
	TMHP 10E	3x3	75 – 280	3,0 – 11,0	120 – 200	4,7 – 7,9	100	11,2		
	TMHC 110E	2x3	50 – 170	1,9 – 6,7	70 – 120	2,8 – 4,7	100	11,2		
	TMHP 15/260	3	195 – 386	7,7 – 15,2	264	10,4	150	16,9		
	TMHP 30/170	3	290 – 500	11,4 – 19,7	170	6,7	300	33,7		
	TMHP 30/350	3	290 – 500	11,4 – 19,7	350	13,7	300	33,7		
	TMHP 30/600	3	290 – 500	11,4 – 19,7	600	23,6	300	33,7		
	TMHP 50/140	3	310 – 506	12,2 – 19,9	140	5,5	500	56,2		
	TMHP 50/320	3	310 – 506	12,2 – 19,9	320	12,6	500	56,2		
	TMHP 50/570	3	310 – 506	12,2 – 19,9	570	22,4	500	56,2		
	<b>A</b>		No. of extension rod sets	Shaft diameter d		Maximum bearing outer diameter		Effective arm length L		Maximum withdrawal force
			mm	in	mm	in	mm	in	kN	ton (US)
TMBS 50E		1	7 – 50	0,3 – 1,9	85	3,3	110	4,3	30	3,4
TMBS 100E		4	20 – 100	0,8 – 3,9	160	6,3	825 (max)	32,5 (max)	100	11,2
TMBS 150E		4	35 – 150	1,4 – 5,9	215	8,5	825 (max)	32,5 (max)	100	11,2
TMHC 110E	2	20 – 100	0,8 – 3,9	160	6,3	255	10	100	11,2	
<b>COMBINED INTERNAL OR EXTERNAL PULL *</b>			Width of grip D		Width of grip d		Effective arm length L		Maximum withdrawal force	
			mm	in	mm	in	mm	in	kN	ton (US)
	TMMR 40F	2	23 – 48	0,9 – 1,9	59 – 67	2,3 – 2,6	65	2,6	15	1,7
	TMMR 60F	2	23 – 68	0,9 – 2,7	62 – 87	2,4 – 3,4	80	3,2	15	1,7
	TMMR 80F	2	41 – 83	1,6 – 3,3	93 – 97	3,7 – 3,8	94	3,7	30	3,4
	TMMR 120F	2	41 – 124	1,6 – 4,9	93 – 138	3,7 – 5,4	120	4,7	30	3,4
	TMMR 160F	2	68 – 164	2,7 – 6,5	114 – 162	4,5 – 6,4	130	5,1	40	4,5
	TMMR 200F	2	67 – 204	2,6 – 8,0	114 – 204	4,5 – 8,0	155	6,1	40	4,5
	TMMR 250F	2	74 – 254	2,9 – 10,0	132 – 252	5,2 – 9,9	178	7,0	50	5,6
	TMMR 350F	2	74 – 354	2,9 – 13,9	135 – 352	5,3 – 13,9	233	9,2	50	5,6
<b>INTERNAL PULL</b>			Shaft diameter d		Hammer displacement		Weight of hammer			
			mm	in	mm	in	kg	lb		
TMSC 6	6	8 – 36	0,3 – 1,4	220	8,7	1,0	2,2			
TMSC 30-60	3	30 – 60	1,2 – 2,4	300	11,8	1,6	3,5			
<b>BLIND PULL *</b>			Bearing bore diameter d		SKF bearing series		Effective arm length L			
			mm	in			mm	in		
TMMD 100	6x3	10 – 100	0,4 – 3,9	60..., 62..., 63..., 62/..., 63/..., 64..., 160..., 161...		135 (min.)	5,3 (min.)			
TMBP 20E	6x2	30 – 160	1,2 – 6,3	60..., 62..., 63..., 64...		600 (max.)	23,6 (max.)			

\* = A bridge construction is needed to support the spindle when used as an internal puller

## Guide to SKF puller accessory selection

Puller series	Designation	Safety Puller Protection Blankets TMMX series	Force Generators Advanced Hydraulic Spindle TMHS series	Trisection Pulling Plates TMMS series
<b>TMMP .x..</b> Standard jaw pullers	TMMP 2x65	–	–	–
	TMMP 2x170	–	–	–
	TMMP 3x185	TMMX 210*	–	TMMS 50* / TMMS 100
	TMMP 3x230	TMMX 210 / TMMX 280*	–	TMMS 50* / TMMS 100
	TMMP 3x300	TMMX 280 / TMMX 350*	–	TMMS 50 / TMMS 100* / TMMS 160
<b>TMMP ..</b> Heavy duty jaw pullers	TMMP 6	TMMX 210	–	TMMS 50*
	TMMP 10	TMMX 280 / TMMX 350	–	TMMS 100*
	TMMP 15	TMMX 350	–	TMMS 100* / TMMS 160*
<b>TMMR ..F</b> Reversible jaw puller	TMMR 40F	–	–	–
	TMMR 60F	–	–	–
	TMMR 80F	–	–	–
	TMMR 120F	TMMX 210	–	–
	TMMR 160F	TMMX 210 / TMMX 280*	–	–
	TMMR 200F	TMMX 280*	–	–
	TMMR 250F	TMMX 350*	–	–
	TMMR 350F	–	–	–
<b>TMMA ..</b> EasyPull	TMMA 60	TMMX 210* / TMMX 280	–	TMMS 50*
	TMMA 80	TMMX 280* / TMMX 350	TMHS 75	TMMS 50* / TMMS 100
	TMMA 120	TMMX 280 / TMMX 350*	TMHS 100	TMMS 50 / TMMS 100* / TMMS 160*
	TMMA 75H	TMMX 280* / TMMX 350	TMHS 75 **	TMMS 50* / TMMS 100
	TMMA 100H	TMMX 280 / TMMX 350*	TMHS 100 **	TMMS 50 / TMMS 100* / TMMS 160*
	TMMA 100H/SET	TMMX 350 **	TMHS 100 **	TMMS160 **
<b>TMHC ..E</b> Hydraulic Puller kit	TMHC 110E	TMMX 280* / TMMX 350	TMHS 100 **	TMMS 50 / TMMS 100*
<b>TMHP ..E</b> Hydraulic Puller kit	TMHP 10E	TMMX 210 / TMMX 280* / TMMX 350	TMHS 100 **	TMMS 50* / TMMS 100* / TMMS 160
<b>TMHP ..</b> Hydraulically– assisted heavy duty jaw pullers	TMHP 15/260	–	–	TMMS 160 / TMMS 260
	TMHP 30/170	–	–	TMMS 260* / TMMS 380
	TMHP 30/350	–	–	TMMS 260* / TMMS 380
	TMHP 30/600	–	–	TMMS 260* / TMMS 380
	TMHP 50/140	–	–	TMMS 260 / TMMS 380*
	TMHP 50/320	–	–	TMMS 260 / TMMS 380*
	TMHP 50/570	–	–	TMMS 260 / TMMS 380*
	TMHP 15/260X	–	–	TMMS 160 / TMMS 260
	TMHP 30/170X	–	–	TMMS 260* / TMMS 380
	TMHP 30/350X	–	–	TMMS 260* / TMMS 380
	TMHP 30/600X	–	–	TMMS 260* / TMMS 380
	TMHP 50/140X	–	–	TMMS 260 / TMMS 380*
	TMHP 50/320X	–	–	TMMS 260 / TMMS 380*
	TMHP 50/570X	–	–	TMMS 260 / TMMS 380*
<b>TMBS ..E</b> Strong back pullers	TMBS 50E	TMMX 210	–	–
	TMBS 100E	TMMX 210* / TMMX 280	TMHS 100 **	–
	TMBS 150E	TMMX 280* / TMMX 350	TMHS 100 **	–
<b>TMSC</b> Internal bearing puller kit	TMSC 6	–	–	–
	TMSC 30–60	–	–	–
<b>TMD 100/TMBP 20E</b> Blind housing puller kits	TMD 100	TMMX 210*	–	–
	TMBP 20E	TMMX 210 / TMMX 280	–	–

\* = recommended / \*\* = accessory included with puller





## Dismounting



### TMMA pullers series: mechanical EasyPull

NEW

#### Safe and simple bearing dismounting

Equipped with spring-operated arms and a solid design, SKF's patented EasyPull is one of the most user-friendly and safe tools on the market. Ergonomically designed, the spring-operated arms enable the user to position the puller behind the component with just one movement.

- Sturdy design allows dismounting of components even in the tightest application in a safe manner
- The unique red rings spring-operated opening mechanism allows the EasyPull to be placed behind the component with one movement of the hands
- Self-locking arms help prevent the risk of puller slipping under load
- Double hexagonal heads allow easier application of withdrawal force
- Self-centring capability and nosepiece help to avoid damage to shaft
- Efficient use of time due to quick dismounting
- Available in three sizes with a withdrawal force of 60, 80 or 120 kN (6,7, 9,0 or 13,5 ton US), enabling easy selection
- Hydraulic force generators available as an accessory for the 80 and 120 kN versions

The mechanical TMMA series consists of 3 (TMMA 60, TMMA 80 and TMMA 100) pullers differing in size and withdrawal force.



### TMMA pullers series: hydraulic EasyPull

NEW

#### Quick and effortless bearing dismounting

The hydraulic versions of the EasyPull, TMMA 75H and TMMA 100H, combine the user friendliness of the mechanical EasyPull with the effortless force generation provided by integrated hydraulic spindles.

- Ready-to-use, integrated hydraulic cylinder, pump and puller – thus it is assembly-free and it is not necessary to purchase separate parts
- Safety valve prevents spindles and pullers from being overloaded if excessive force is applied
- The spring-loaded centre point on the hydraulic spindle allows easy centring of the puller on the shaft without damaging the shaft
- The TMMA 100H has a maximum withdrawal force of 100 kN (11,2 ton US) and a long stroke of 80 mm (3,1 in), which facilitates most dismounting jobs in just one operation
- For dismounting jobs requiring less force, SKF offers a 75 kN (8,4 ton US) version, the hydraulic EasyPull TMMA 75H with a maximum stroke of 75 mm (3 in)
- Supplied with extension pieces and one nosepiece

The pullers are protected from overload by safety valves built in their hydraulic spindles.



## TMMA pullers series: hydraulic EasyPull set

NEW

### A complete bearing dismounting solution

The SKF hydraulic EasyPull set, TMMA 100H/SET, is the most complete dismounting kit available on the market. The set offers the unique combination of the hydraulic EasyPull, a tri-section pulling plate and a puller protection blanket.

Combined together, the components of the set facilitate safe and easy dismounting of bearings, such as spherical roller and CARB® bearings, or other components, such as pulleys and flywheels.

In addition to the benefits of the TMMA 100H, which is the essential part of the set, the TMMA 100H/SET also includes:

- A tri-section pulling plate, TMMS 160, that facilitates easy and virtually damage-free dismounting, especially of spherical roller and CARB® bearings
- A puller protection blanket, TMMX 350, which is made of transparent material so the user can visually follow the dismounting procedure. It also increases the user's safety while dismounting as it helps to protect from flying fragments of bearings or other components
- A durable metal storage case filled with custom made storage facilities for all parts, minimizing the risk of losing or damaging any of the components
- A complete solution for effortless and safe dismounting for many bearing types, especially spherical roller and CARB® bearings, as well other components such as pulleys and flywheels



136



## Tri-section pulling plates TMMS Series

### Efficient and correct dismounting

The tri-section pulling plates, TMMS series, are especially designed for use in combination with three-armed pullers. The plates grip behind the inner ring of the bearing. This prevents the pulling forces from being transmitted through

the outer ring and the rolling elements, minimising the risk of bearing damage. The TMMS series consists of 5 different sizes of tri-section pulling plates suitable for shafts with maximum diameter ranging from 50 to 380 mm (2 to 15 in).

- The firm grip behind the bearing's inner ring helps ensure that the pulling forces are only transmitted through the inner ring and not through the outer ring or the rolling elements, preventing bearing damage
- The tri-section construction allows even force distribution, preventing bearing locking and/or tilting on the shaft, especially in the case of spherical roller and CARB® bearings, during dismounting
- Suitable for use in combination with three-armed pullers
- Special wedge shape design allows the plates to be easily inserted between the bearing and the shoulder on the shaft
- Available in a wide range, covering most common shaft sizes

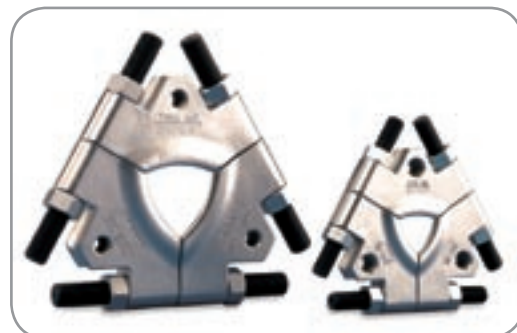

136



# Dismounting



## Advanced hydraulic spindles TMHS 75 and TMHS 100



### Effortless withdrawal force generation

The SKF advanced hydraulic spindles TMHS 75 and TMHS 100 generate a high pulling force with very little effort compared to the standard mechanical spindles. They dramatically reduce the time needed to dismount a bearing or other component.

The spindles are equipped with integrated hydraulic pumps for force generation. Maximum pulling forces are limited by special safety valves and the hydraulic oil will remain inside the pump.

- Integrated hydraulic cylinder, pump and spindle – no separate pump is required
- Safety valve helps prevent overloading the spindle and the puller in case excessive force is applied
- Spring-loaded centre point in the nosepiece allows easy centring of the puller on the shaft without damaging shaft centre point
- Hand lever with ergonomic grip can be rotated 360
- Hardened and chrome plated piston with spring return function
- Extension pieces included allows easy adaptation for the required pulling length

#### TMHS 75:

- The TMHS 75 has a maximum withdrawal force of 75 kN (8.4 ton (US)) and a long stroke length of 75 mm (3.0 in), which allows dismounting in one operation
- Suitable for use with any puller equipped with a UN 1 $\frac{1}{4}$ " x 12 tpi threading that can be used up to the maximum force of 75 kN (8.4 ton (US))
- Delivered with a 50 (2.0 in) and 100 mm (3.9 in) extension piece

#### TMHS 100:

- The TMHS 100 has a maximum withdrawal force of 100 kN (11.2 ton (US)) and a long stroke of 80 mm (3.1 in), which allows dismounting in one operation
- Suitable for use with any puller equipped with a UN 1 $\frac{1}{2}$ " x 16 tpi threading that can be used up to the maximum force of 100 kN (11.2 ton (US))
- Delivered with a 50 (2.0 in), 100 mm (3.9 in) and 150 mm (5.9 in) extension piece



### SKF force generator selection

Puller	Mechanical spindle	TMHS 75	TMHS 100
TMMA 60	■		
TMMA 80	■	●	
TMMA 120			●
TMMA 75H		■	
TMMA 100H			■
TMMA 100H/SET			■
TMBS 50E	■		
TMBS 100E			■
TMBS 150E			■
TMHC 110E			■
TMHP 10E			■

■ = Standard with puller    ● = Accessory for puller

## Standard jaw pullers TMMP series

### Versatile two and three arm mechanical pullers

One of the most common ways to dismount small to medium size bearings is to use a basic mechanical puller. Using an SKF puller helps to safeguard against damage caused to the

bearing or to the bearing seating during dismounting. SKF standard jaw pullers offer you easy and safe puller operation.

- Range of five different jaw pullers with two or three arms
- Maximum nominal span from 65 to 300 mm (2,6 to 11,8 in)
- Cone system for automatic centring and secure positioning of arms
- Strong springs keep arms apart for easy operation
- Hardened, high quality carbon steel



## Reversible jaw puller TMMR F series

### Combined internal and external puller

The multipurpose SKF TMMR F jaw pullers are able to grip on both the outside as well as the inside of a component, with equal strength. The TMMR F's are available as a complete set, TMMR 8.

- Both internal and external pulling
- Puller for use in every workshop
- Self-locking arms
- Special safety neck avoids damaging of thread and arms
- Hexagonal head on beam allows rotation of bearing during dismounting
- Gripping range from 23 to 350 mm (0,9 to 13,8 in)
- Also available as complete set on a stand





# Dismounting



## Heavy-duty jaw pullers TMMP series

### Powerful self-centring mechanical pullers

The SKF TMMP heavy-duty jaw pullers provide perfect alignment and shaft protection as well as an exceptional grip for medium to large size bearings.

- 3 arm jaw pullers with a maximum withdrawal force of 60 to 150 kN (6,7 to 17,0 ton US)
- Unique pantograph system for grip width adjustment that counteracts misalignment during operation
- Fast, efficient and smooth handling
- Blackened, high quality steel for corrosion resistance



## Hydraulically assisted heavy duty jaw pullers TMHP series

### Powerful self-centring hydraulic pullers

The SKF hydraulically assisted pullers TMHP 15, TMHP 30 and TMHP 50 are both safe and powerful. They also have a self-centring ability, which is necessary when applying large forces.

- Hydraulically assisted pullers with a maximum withdrawal force of 150, 300 or 500 kN (17,0, 34,0 or 56,0 ton US)
- Pantograph system for ultimate alignment of withdrawal forces and minimised risk of damaging shaft or bearing
- Extreme forces can be applied with ease (self-centring, lifting handle and eye bolt)
- The combination of a spindle and hydraulic cylinder allows the working length to be easily adjusted
- Can be supplied with or without the SKF hydraulic pump TMJL 100

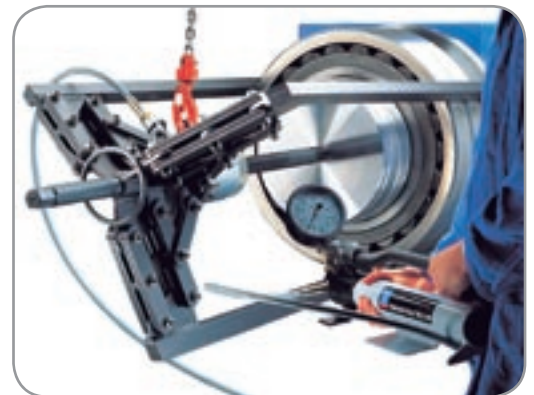

## Hydraulic jaw puller kit TMHP 10E

### Effortless bearing dismounting up to 100 kN

The SKF TMHP 10E jaw puller kit is equipped with a hydraulic spindle, which facilitates effortless bearing dismounting up to 100 kN (11,2 ton US).

- High load rating of 100 kN (11,2 ton US) makes the puller suitable for a variety of dismounting jobs
- The 3 different arm sizes, with a maximum effective arm length of 200 mm (7,9 in), make the TMHP 10E suitable for use in a wide range of applications
- The self-locking arms minimise the risk of the puller slipping from the application when under load
- Hydraulic spindle facilitates effortless dismounting
- The hydraulic spindle is equipped with a safety valve, which minimises the risk of puller overload by limiting the applied force to 100 kN (11,2 ton US)
- Long stroke of hydraulic spindle, 80 mm (3,1 in), facilitates dismounting in one operation

The versatile puller kit includes three different arm sizes and can be assembled as a two-arm puller or a three-arm puller depending on the space and demand of the application.

- Extension pieces of the hydraulic spindle allow quick adaptation to pulling length
- The spring-loaded centre point of the hydraulic spindle allows easy centring of the puller on the shaft without damaging it



## Hydraulic puller kit TMHC 110E

### Powerful combination of a jaw and strong back puller

The SKF TMHC 110E is a hydraulic puller kit, which combines a jaw puller and a strong back puller with up to 100 kN

- Unique combination of a hydraulic jaw and a strong back puller for use in various applications
- High load rating of 100 kN (11,2 ton US) make the TMHC 110E suitable for use in many applications
- Hydraulic spindle facilitates easy and quick dismounting, effortless generation of force
- The jaw puller includes 2 different arm sizes for maximum reach of 120 mm (4,7 in)
- The jaw puller can be assembled as a three-arm or two-arm puller depending on the space and demands of the application

(11,2 ton US) pulling power. The versatile puller kit facilitates safe and easy dismounting in a variety of applications.

- The firm grip of the strong back puller behind the bearing's inner ring reduces the force required to dismount the bearing
- The special separator design of the strong back puller allows the puller to be used even in the tightest spaces
- The extension rods of the strong back puller allow a maximum reach of 255 mm (10 in) for quick adaptation to required pulling length

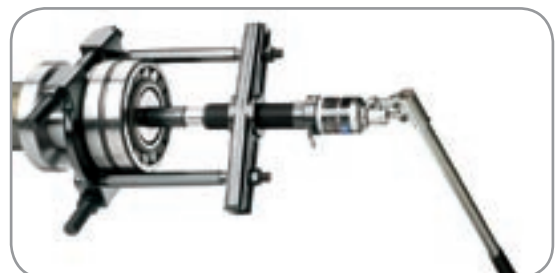



# Dismounting



## Strong back pullers TMBS E series

### Easy bearing dismounting even in the tightest spaces

The SKF TMBS E strong back pullers facilitate dismounting of bearings in applications where the use of traditional jaw pullers is restricted due to lack of space or where the application demands a long reach.

- Special separator design allows the puller to be easily inserted between the bearing and the shoulder on the shaft, even in the tightest spaces
- The firm grip behind the bearing's inner ring reduces the force required to dismount the bearing
- High load rating of 100 kN (11,2 ton US) make the TMBS 100E and TMBS 150E suitable for use in many applications
- TMBS 100E and TMBS 150E offer complete hydraulic puller kits, allowing effortless generation of force
- The extension rods of the TMBS 100E and TMBS 150E allow easy and quick adaptation to required pulling length
- Maximum reach of 825 mm (32,5 in) and maximum shaft diameter of 150 mm (6 in) allow the TMBS E series to be used in many applications
- The hydraulic spindle is equipped with a safety valve, which limits the applied force to 100 kN (11,2 ton US), minimising the risk of puller overload
- The spring-loaded centre point of the hydraulic spindle allows easy centring of the puller on the shaft without damaging it

TMBS 100E and the TMBS 150E are equipped with a hydraulic spindle, which allows for effortless application of force up to 100 kN (11,2 ton US). The TMBS 50E is equipped with a mechanical spindle for force generation.

- Long stroke of hydraulic spindle, 80 mm (3,1 in), facilitates dismounting in one operation
- Pumping mechanism used for force generation is effortless and more efficient than turning mechanism
- Extension pieces of the hydraulic spindle allow quick adaptation to pulling length

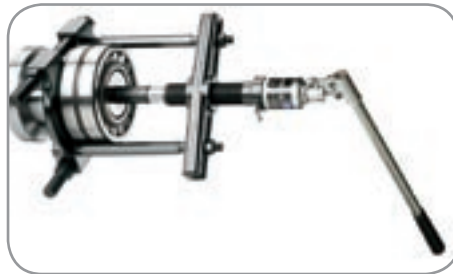

# Deep groove ball bearing puller kit TMMD 100



## Easy dismounting of bearings in blind housings

The SKF TMMD 100 is especially designed to allow easy and quick dismounting of deep groove ball bearings with interference fit on both rings. The puller is suitable for use in both blind housings and shaft applications. The puller kit contains six sets of different size puller arms,

two spindles and one handle packed in a carrying case. The TMMD 100 is suitable for dismounting up to 71 different SKF deep groove ball bearings from shaft diameter ranging between 10 and 100 mm (0,4 – 3,9 in).

- The claws are especially designed to facilitate a precise fit in the bearing's raceways, providing exceptional grip and allowing the application of higher dismounting forces
- Each puller arm is fitted with a spring for easy installation
- The puller arms are made of a single piece, laser-cut hardened-steel for strength and longevity
- The hexagon head of the spindle is equipped with an anti-slip pin, which prevents the spanner from sliding down the spindle during dismounting
- The rotation angle of the claw has been limited to allow easy insertion
- The designation is laser-engraved on the arms allowing easy identification and selection
- In addition to dismounting open bearings, the TMMD 100 can be used to dismount sealed bearings after the removal of the seal

- A** Bearing selection chart included
- B** The rubber cap allows easy and quick attachment of the arms to the spindle. It also prevents the puller arms from detaching from the spindle during operation
- C** The springs are colour-coded for easy arm selection and matching







# Dismounting



## Selection table

DGBB bearing series	Spindle TMMD 100-S1				Spindle TMMD 100-S2						
	TMMD 100 A1	TMMD 100 A2	TMMD 100 A3	TMMD 100 A4	TMMD 100 A5		TMMD 100 A6				
60..	6000 6001 6002	6004 6005 6006	6007 6008 6009	6011 6012 6013	6014 6015	6016 6017	6018 6019 6020				
62..	6200	6201 6202 6203	6204 6205	6206	6207 6208	6209	6210 6211	6212 6213	6214 6215 6216 6217	6218	
63..		6300	6301 6302 62/22	6303 6304 62/28	6305	6306	6307	6308	6309 6310	6311 6312	6313
62/ 63/ 64..				63/22	63/28	6403	6404 6405	6406	6407	6408 6409	6410
160..	16002 16003		16011								
161..	16100 16101										

## Internal bearing puller kits TMSC series

### Slide impact hammer assisted pullers

The SKF TMSC internal bearing puller kits are ideal for removing bearings from housings that are difficult to reach with conventional pullers. The TMSC 6 kit is supplied with 6 different adjustable collets covering bore diameters from

8 to 36 mm (0,3 to 1,4 in), and the TMSC 30-60 kit with 3 different collets covering bore diameters from 30 to 60 mm (1,2 to 2,4 in)

- Easy removal of bearings from housings
- Positive bearing grip through collet expansion
- Minimises housing damage
- Six segment collets for efficient force application/transmission



140

- Insert the extractor through the bore of the bearing
- Tighten the collet nut in order to expand the extractor behind the bearing
- Connect the slide hammer. Extract by throwing the hammer towards the handle

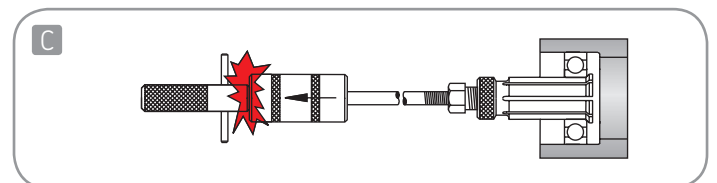
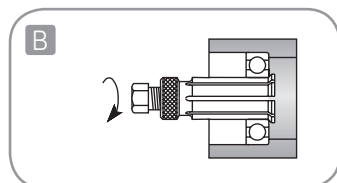
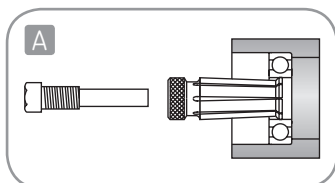

## Puller protection blankets TMMX series

### For safety during dismounting

The SKF puller protection blankets, TMMX series, are especially designed to offer additional safety during the dismounting bearings or other components. The TMMX series blankets are simply wrapped around the puller and application after the puller has been positioned.

- Offers additional protection for the user during dismounting jobs
- The tough, transparent plastic allows the user to monitor the component and the puller during operation
- Suitable for use in combination with many pullers
- Especially designed to fit SKF pullers TMM series



## Blind housing puller kit TMBP 20E

### Removes bearing without dismantling machinery

NEW

The SKF TMBP 20E is an adapter type puller for dismounting of deep groove ball bearings in blind housings.

Special design for applications where the bearing cannot be easily grabbed from the back side such as blind housing and shaft applications. The use of extension rods also allows a long reach, up to 583 mm (23 in).

- With 6 sets of adaptors, a wide range of deep groove ball bearings can be dismounted
- New ball adapters are more durable
- Spanner stop function on spindle for easy and safe handling
- Special nose piece helps in minimizing damage to shaft and improves puller stability
- Nosepiece with self-locking function

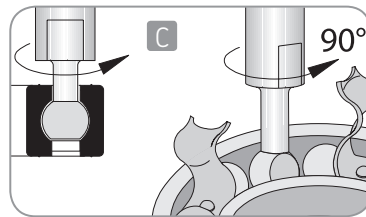
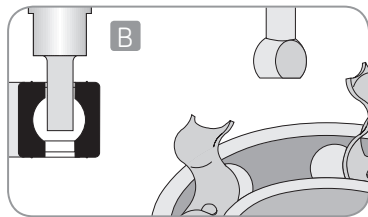
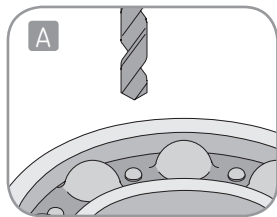

- A** Remove seal and open selected section of ball cage. Clean the swarf out.
- B** Insert appropriate bearing adapter and rotate it 90° ensuring positive grip within the bearing race.
- C** Insert the second adapter into prepared area diametrically opposed.



# Dismounting



## Other dismounting tools

SKF also offers a wide range of mechanical tools, which facilitate dismounting. For more details on these tools,

please see pages 13 – 15 of the Mounting and Lubrication section of this catalogue.

### Index other mechanical dismounting tools

Designation	Description	Page
HN series	Hook spanners	13
HNA series	Adjustable hook spanners	13
HN ../SNL series	Hook spanners for SNL housings	14
TMFN series	Impact spanners	14
TMFS series	Axial lock nut sockets	15

# Dismounting using heat

## Easy, quick and safe dismounting of cylindrical roller bearing inner rings

SKF's range of heating equipment enables quick and safe dismounting of cylindrical roller bearing inner rings and covers a wide range of applications. Aluminium heating rings TMBR series are designed for dismounting inner rings of small and medium-size cylindrical roller bearings.

Adjustable and fixed induction heaters EAZ series are suitable for frequent dismounting of various sizes of cylindrical roller bearing inner rings.

## Aluminium heating rings TMBR series

### For regular dismounting of cylindrical roller bearings

The aluminium heating rings are designed for dismounting inner rings of cylindrical roller bearings. They are available for all bearing sizes of the NU, NJ and NUP series, these are

bearings without flanges or with only one flange on the inner ring. The rings are available as standard for the following bearing sizes: 204 to 252, 304 to 340, 406 to 430.

- Simple and easy-to-use
- Avoids shaft and bearing inner ring damage



## Adjustable induction heaters EAZ series

### For frequent dismounting of cylindrical roller bearings

The adjustable induction heaters EAZ 80/130 and EAZ 130/170 are used for frequent dismounting of cylindrical bearing inner rings. Where inner rings are removed infrequently, aluminium heating rings, TMBR series, are also available.

- Covers most cylindrical bearings 65 to 130 mm (2,5 to 5,1 in) bore diameter
- Wide range of power supplies
- 1 year warranty
- Avoids shaft and bearing inner ring damage
- Fast and reliable bearing removal
- Up to n6 interference fit

For larger cylindrical inner rings normally found in steel mill applications, SKF can supply special EAZ induction heaters.

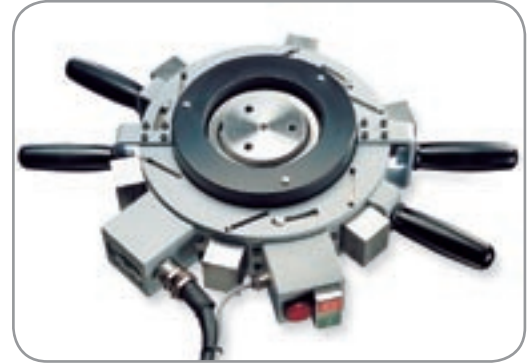

#### Selection table for bearings NJ–NUP

Designation						
EAZ 80/130	213–220	313–319	412–417	1014–1022	2213–2220	2313–2319
EAZ 130/170	222–228	321–324	419–422	1024–1030	2222–2228	2322–2324

All E–types included.

#### Selection table for bearings NU

Designation						
EAZ 80/130	213–221	313–320	412–418	1014–1022	2213–2220	2313–2320
EAZ 130/170	222–228	321–326	419–424	1024–1030	2222–2228	2322–2326

All E–types included.

## Fixed induction heaters EAZ series

### Quick roll changes with bearing removal in 3 minutes

In light section mills and wire rod mills, four–row cylindrical roller bearings are usually used to take up the roll separating forces. The inner rings of these bearings are mounted with an interference fit on the roll necks.

#### Three minutes are enough

Using the EAZ, inner rings are heated evenly while the roll neck remains cold. The ring, together with the induction heater, can be easily withdrawn from the neck. Even with relatively large rings this complete operation takes not more than two to three minutes.

- Reduced time to remove bearings
- Increased production time
- Available in different voltage versions
- Bearings can be reused
- Control cabinet is to be ordered separately

Because of the rapid wear, heavy loads and severe contamination the rolls must be frequently replaced. This inevitably involves dismounting the inner rings and remounting them onto new rolls.





## Dismounting bearings using hydraulic techniques

### Correct and quick bearing dismounting

Using SKF hydraulic techniques for bearing dismounting reduces the risk of damaging the bearing or its seating. Additionally, greater withdrawal forces can be applied with minimum effort and maximum control, allowing quick and safe dismounting.

### The SKF Oil injection method

#### Easy, quick and effortless bearing dismounting

When using the SKF Oil Injection Method the mating surfaces are separated by a thin film of oil injected under high pressure, thereby virtually eliminating the friction between them. The method is versatile as it can be used for dismounting bearings and other components mounted on either cylindrical or tapered seatings. When dismounting bearings mounted on cylindrical seatings, the injected oil can reduce the required pulling forces by up to 90%.

Subsequently, the physical effort required when using a puller to remove the bearing from its seating is reduced. When using the Oil Injection Method to dismount bearings mounted on tapered seatings, the interference fit is completely overcome by the injected oil. The bearing is then ejected from the seating with great force, making the use of a puller unnecessary. In this case, a stop-nut must be used to control the ejection of the bearing.

The method, which is used for many bearing applications, can also be found in other applications, such as:

- Couplings
- Gear wheels
- Railway wheels
- Propellers
- Built-up crankshafts

#### Cylindrical shafts

##### The concept

**A** By injecting oil of a certain viscosity between two shrink fitted surfaces, the mating surfaces will be separated by a thin oil film. The dismounting force required is thus greatly reduced. The thin oil film also minimises the risk of metallic contact when dismounting, reducing the risk of component damage.

##### The preparation

**B** During manufacture the shafts are prepared with oil ducts and grooves. For technical information on how to prepare the shafts, consult an SKF application engineer.

##### The action

**C** Dismounting the bearing is made easy by pumping oil under pressure between the mating surfaces. Once the oil pressure has built up, the component can be removed from the shaft with a minimum of effort.

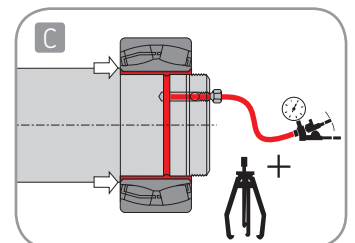
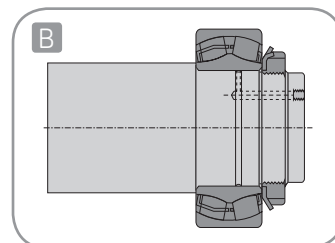
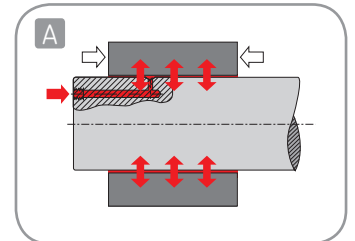

## Tapered shafts

### The concept

**A** Injecting the oil between two tapered surfaces will create a reaction force which could be quite substantial as the oil will also act as a "hydraulic cylinder" which can push the outer component off.

### The preparation

**B** During manufacture the shafts are prepared with oil ducts and grooves. For technical information on how to prepare the shafts, consult an SKF application engineer.

### The action

**C** Bearings are dismantled by injecting oil between the mating surfaces and when sufficient pressure is reached, the bearing will be pushed off. A nut is required to keep the bearing from sliding off the shaft.

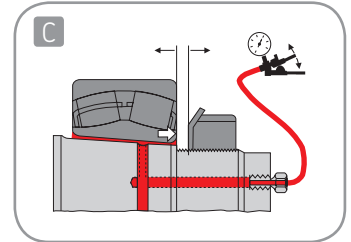
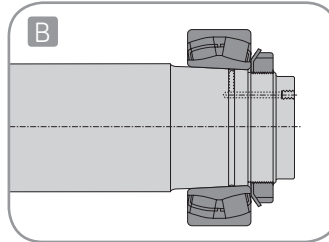
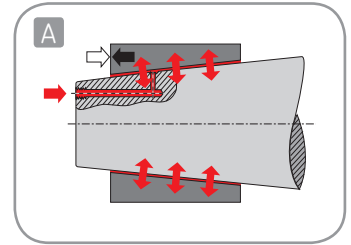

In addition to dismantling bearings mounted on cylindrical or tapered seatings, the SKF Oil Injection Method can be also used for mounting bearings on tapered seatings. See page 22-23 of this catalogue for more details.

## Hydraulic nuts HMV ..E series

### Effortless dismantling of bearings mounted on sleeves

Dismounting bearings mounted on either adapter or withdrawal sleeves is often a difficult and time-consuming job. These problems can be reduced with the use of an SKF hydraulic nut. Oil is pumped into the nut and the piston is pushed out with a force, which is sufficient to free the sleeve. All HMV ..E nuts are supplied with a quick connection coupling to fit the SKF hydraulic pumps.



**A** HMV ..E nut and stop ring in position to press an adapter sleeve free.

**B** HMV ..E nut used to free a withdrawal sleeve.

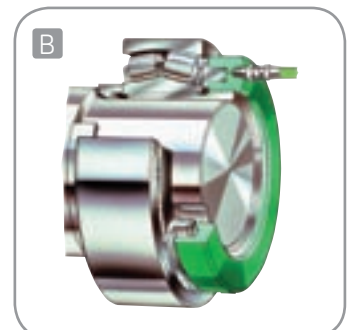
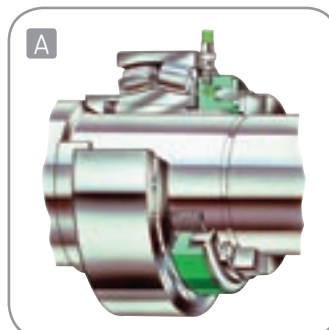

SKF hydraulic nuts HMV ..E series also facilitate bearing mounting. For more details see page 26 of this catalogue.



# Dismounting



## Dismounting fluid LHDF 900

### For easy and quick bearing dismounting

The dismounting fluid LHDF 900 is suitable for use with SKF hydraulic equipment, including hydraulic pumps and oil injection tools. The LHDF 900 contains anti corrosives which

are non aggressive to seal materials such as nitrile rubber, perbunan, leather and chrome leather, PTFE, and so on.

#### Ordering details and technical data

Designation	LHDF 900/pack size
Specific gravity	0,885
Flash point	202 °C (395 °F)
Pour point	-28 °C (-18 °F)
Viscosity at 20 °C (68 °F)	910 mm <sup>2</sup> /s
Viscosity at 40 °C (104 °F)	330 mm <sup>2</sup> /s
Viscosity at 100 °C (212 °F)	43 mm <sup>2</sup> /s
Viscosity index	180
Available pack size	5 and 205 litre



## Hydraulic pumps and oil injectors selection guide

SKF offers a wide range of hydraulic equipment, which facilitates the dismounting of bearings and other components. This selection guide features the most common applications for which the equipment can be used.

For more details on these hydraulic pumps and oil injectors, please see pages 29 – 36 of the Mounting and Lubrication section of this catalogue.

#### Ordering details and dimensions

Max. working pressure	Pump	Type	Oil container capacity	Dismounting applications*
30 MPa (4,350 psi)	THAP 030	Air-driven pump	Separate container oil	OK couplings hydraulic chamber
50 MPa (7,250 psi)	TMJL 50	Hand operated pump	2 700 cm <sup>3</sup> (165 in <sup>3</sup> )	≥ HMV 92E with sleeves OK couplings
100 MPa (14,500 psi)	729124	Hand operated pump	250 cm <sup>3</sup> (15 in <sup>3</sup> )	≤ HMV 54E with sleeves Oil injection for small bearings
	TMJL 100	Hand operated pump	800 cm <sup>3</sup> (48 in <sup>3</sup> )	≤ HMV 92E with sleeves Oil injection for medium bearings
150 MPa (21,750 psi)	THAP 150	Air-driven pump	Separate container	Bolt tensioners, propellers Oil injection for bearing seatings
	728619 E	Hand operated pump	2 550 cm <sup>3</sup> (155 in <sup>3</sup> )	All HMV E nuts with sleeves Oil injection for bearing seatings
300 MPa (43,500 psi)	THAP 300E	Air-driven pump	Separate container	OK couplings Large pressure joints Oil injection for bearing seatings
	226400	Hand operated oil injector	200 cm <sup>3</sup> (12,2 in <sup>3</sup> )	OK couplings Adapter / withdrawal sleeves Oil injection for bearing seatings
	729101 B TMJE 300	Oil injection kit Oil injection set	200 cm <sup>3</sup> (12,2 in <sup>3</sup> ) 200 cm <sup>3</sup> (12,2 in <sup>3</sup> )	Complete kit / set to suit many applications Complete kit / set to suit many applications
	226270	Screw injector	5,5 cm <sup>3</sup> (0,33 in <sup>3</sup> )	Machine tool applications shaft diameter ≤ 100 mm
400 MPa (58,000 psi)	226271	Screw injector	25 cm <sup>3</sup> (1,5 in <sup>3</sup> )	Machine tool applications shaft diameter ≤ 200 mm
	226400/ 400MPa	Hand operated oil injector	200 cm <sup>3</sup> (12,2 in <sup>3</sup> )	Joints with high interference fits
	729101 E TMJE 400	Oil injection kit Oil injection set	200 cm <sup>3</sup> (12,2 in <sup>3</sup> ) 200 cm <sup>3</sup> (12,2 in <sup>3</sup> )	Complete kit / set to suit many applications Complete kit / set to suit many applications

\* The dismounting applications given above are for guidance only.  
The interference fit present may mean that a pump / injector with a higher-pressure capacity is required.



# SKF Support

SKF Internet sites	112
SKF Drive-up Method	112
SKF Oil injection Method	112
SKF DialSet 3.0 Re-lubrication calculation program	112
SKF Demonstration trucks	113
Audio visual	113
Technical literature	113
Training	113



# SKF Support

Reduced machinery downtime through effective bearing maintenance

Product quality is just one of the factors that determine bearing service life. Operating environment, proper installation and maintenance are also critical to bearing performance; factors that enter the picture after the bearing has been delivered to our customers.



## SKF Internet sites

At [www.mapro.skf.com](http://www.mapro.skf.com) you will find the SKF Maintenance Products catalogue online, offering a complete listing of products and technical specifications in many languages. There, you can also find a wealth of information about bearing maintenance practices as well as an extensive "frequently asked questions" section. For information on the SKF Group, history, products, divisions and services worldwide visit the SKF Group site at [www.skf.com](http://www.skf.com).



## SKF Drive-up Method

The SKF Drive-up Method CD-ROM program is a computerized handbook on how to use the Drive-up Method for mounting bearings with a tapered bore. The program describes the method with the aid of pictures, animations, videos, and calculation tables that can easily be printed. The program is available in English, German, Swedish, French, Italian and Spanish. Reference no. MP3600



## SKF Oil Injection Method

The SKF Oil Injection Method allows bearings and other components with an interference fit to be fitted and removed in a safe, controllable and rapid manner. The CD-ROM revolutionizes the method by fully automating the technique, making the detailed calculations easy and simple to compute. The CD-ROM provides detailed instructions and practical information on how to use the method for mounting and dismounting bearings, as well as using the method in design, calculation and application of shrink fitted components. Reference no. MP3601



## SKF DialSet 3.0 Re-lubrication calculation program

The SKF DialSet 3.0 Re-lubrication Calculation program enables accurate calculation of re-lubrication intervals for lubricating bearings. The computer program determines the right time setting and dispense rates for SYSTEM 24 and SYSTEM MultiPoint. It also recommends when to use SYSTEM 24 LAGD 125 or LAGD 60. The program is available on diskette and is translated into English, French, German, Swedish, Spanish and Italian languages. Reference no. MP3506. It is also available in English online as well as downloadable version for PDA from [www.mapro.skf.com](http://www.mapro.skf.com).

At SKF we have put together the industry's most comprehensive program for maximising bearing service life and to help our customers reduce costly machine stoppages due to bearing failures..

*For more information on the services described below, please contact your nearest SKF supplier*



#### **SKF Demonstration trucks**

SKF offers demonstrations and training with mobile demonstration vehicles which tour throughout Europe, Asia and North America. The training program is tailored to the customer's needs and may consist of a short theoretical explanation of the latest maintenance methods and concepts, followed by a detailed hands-on demonstration with qualified SKF personnel. For more information about these vehicles, please contact your local distributor or SKF office to schedule an appointment.

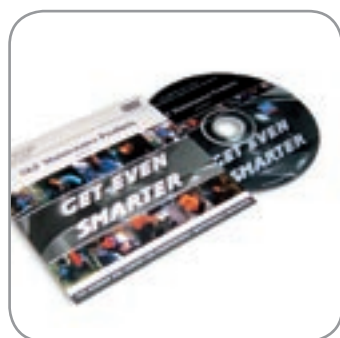

#### **Audio visual**

SKF provides a range of videos to support training courses on different facets of bearing and seal performance. The "Get Even Smarter" video shows the do's and don't-s of good bearing maintenance in a light-hearted way.



#### **Technical literature**

SKF technical literature is a must in every maintenance workshop. The SKF General Catalogue and the unique SKF Bearing Maintenance Handbook provide the answers to all mounting and dismounting questions.



#### **Training**

SKF offers training courses on all facets of bearing maintenance and machine reliability. By prior arrangement training courses can be organised at our customer's own premises or at one of our well-equipped SKF Maintenance Support Centres. If you would like to know what courses are offered in your area, talk to your local SKF representative or visit [www.skf.com](http://www.skf.com).

# Technical data

## TMFT 36 (page 11)

<b>Designation</b>	<b>TMFT 36</b>
<b>Description</b>	Fitting tool kit
<b>Impact rings</b>	Bore diameter 10 – 55 mm (0,39 – 2,1 in) Outer diameter: 26 – 120 mm (1,02 – 4,7 in)
<b>Sleeves</b>	Bore diameter: 18,5, 37,5 and 57,5 mm (0,7, 1,5, 2,3 in) Outer diameter: 25, 45 and 66 mm (1,0, 1,7, 2,6 in)
<b>Hammer</b>	TMFT 36-H, weight 1 kg (2,2 lb)
<b>Dimensions of the case</b>	525 × 420 × 130 mm (20,6 × 16,5 × 5,1 in)
<b>Number of rings</b>	36
<b>Number of sleeves</b>	3
<b>Weight (including carrying case)</b>	4 kg (8,8 lb)

## TMHN 7 (page 13)

<b>Designation</b>	<b>TMHN 7</b>
<b>Dimensions of case (w × d × h)</b>	340 × 250 × 80 mm (13,4 × 9,8 × 3,1 in)
<b>Weight</b>	2,2 kg (4,7 lb)

## TMHN 7 selection chart

Spanner	Bearing designation				Spanner	Bearing designation			
<b>HNM 5</b>	1205 EK	2205 EK	1305 EK	2306 K	<b>HNM 9</b>	1209 EK	2209 EK	1309 EK	2309 EK
<b>HNM 6</b>	1206 EK	2206 EK	1306 EK	2307 EK	<b>HNM 10</b>	1210 EK	2210 EK	1310 EK	2310 K
<b>HNM 7</b>	1207 EK	2207 EK	1307 EK	2308 EK	<b>HNM 11</b>	1211 EK	2211 EK	1311 EK	2311 K
<b>HNM 8</b>	1208 EK	2208 EK	1308 EK						

## HN series (page 13)

<b>Designation</b>	HN ... (see table below)
<b>Description</b>	Hook spanner
<b>Material</b>	Special hardened steel
<b>Material handle</b>	PVC
<b>Suitable</b>	For many SKF nuts For all KM nuts according to DIN 981 For all nuts according to DIN 1804 For nuts from KMO (Ø18) to KM22 (Ø145)

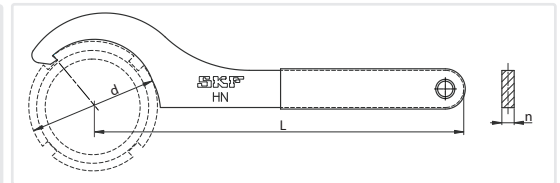

Designation	Spanner design DIN 1810 mm	Diameter d		Working length L		Thickness n		Weight		
		mm	in	mm	in	mm	in	g	lb	
HN 0	Ø20 – Ø22	16 – 20	0,6 – 0,8	100	3,9	3	0,12	24	0,05	
HN 1		20 – 22	0,8 – 0,9	100	3,9	3	0,12	25	0,06	
HN 2-3		Ø25 – Ø28	25 – 28	1,0 – 1,1	120	4,7	4	0,16	48	0,11
HN 4		Ø30 – Ø32	30 – 32	1,2 – 1,3	120	4,7	4	0,16	48	0,11
HN 5-6	Ø52 – Ø55	38 – 45	1,5 – 1,8	150	5,9	5	0,20	96	0,21	
HN 7		52 – 55	2,0 – 2,2	180	7,1	6	0,24	170	0,37	
HN 8-9	Ø68 – Ø75	58 – 65	2,3 – 2,6	210	8,3	7	0,28	270	0,60	
HN 10-11		68 – 75	2,7 – 3,0	210	8,3	7	0,28	270	0,60	
HN 12-13	Ø80 – Ø90	80 – 90	3,1 – 3,5	240	9,4	8	0,31	420	0,93	
HN 14		92	3,6	240	9,4	8	0,31	415	0,91	
HN 15	Ø95 – Ø100	95 – 100	3,7 – 3,9	240	9,4	8	0,31	405	0,89	
HN 16		105	4,1	240	9,4	8	0,31	412	0,91	
HN 17	Ø110 – Ø115	110 – 115	4,3 – 4,5	280	11,0	10	0,39	753	1,66	
HN 18-20	Ø120 – Ø130	120 – 130	4,7 – 5,1	280	11,0	10	0,39	752	1,66	
HN 21-22		Ø135 – Ø145	135 – 145	5,3 – 5,7	320	12,6	12	0,47	1210	2,67

## HN series Selection chart

Designation	Suitable for SKF nuts of series						DIN 1804 (M)
	KM	N	AN	KMK	KMFE	KMT	
HN 0	0	0		0			M6 × 0,75, M8 × 1
HN 1	1	1		1			M8 × 1
HN 2-3	2, 3	2, 3		2, 3		0	M10 × 1, M12 × 1,5
HN 4	4	4		4	4	1, 2	M14 × 1,5, M16 × 1,5
HN 5-6	5, 6	5, 6		5, 6	5, 6	3, 4, 5	M22 × 1,5, M24 × 1,5, M26 × 1,5
HN 7	7	7		7	7	6, 7	M32 × 1,5, M35 × 1,5
HN 8-9	8, 9	8, 9		8, 9	8, 9	8	M38 × 1,5, M40 × 1,5, M42 × 1,5
HN 10-11	10, 11	10, 11		10, 11	10, 11	9, 10	M45 × 1,5, M48 × 1,5, M50 × 1,5
HN 12-13	12, 13	12, 13		12, 13	12, 13	11, 12	M52 × 1,5, M55 × 1,5, M58 × 1,5, M60 × 1,5
HN 14	14		14	14	14		M62 × 1,5, M65 × 1,5, M68 × 1,5, M70 × 1,5
HN 15	15		15	15	15	13, 14	
HN 16	16		16	16	16	15	
HN 17	17		17	17	17	16	M72 × 1,5, M75 × 1,5, M80 × 2
HN 18-20	18, 19, 20		18, 19, 20	18, 19, 20	18, 19, 20	17, 18, 19	M85 × 2, M90 × 2
HN 21-22	21, 22		21, 22	21, 22	21, 22	20, 22	M95 × 2, M100 × 2

### HNA series (page 13)

Designation	Description	Diameter			Working length L	Thickness			Weight	
		mm	in	mm		mm	in	g	lb	
HNA 1-4	size 1 - 4	20 - 35	0,8 - 1,4	120	4,7	6	0,24	50	0,11	
HNA 5-8	size 5 - 8	35 - 60	1,4 - 2,4	150	5,9	8	0,31	100	0,22	
HNA 9-13	size 9 - 13	60 - 90	2,4 - 3,5	210	8,3	10	0,39	285	0,63	
HNA 14-24	size 14 - 24	90 - 15	3,5 - 6,1	240	9,4	12	0,47	450	0,99	

#### Designation

#### Suitable for SKF nuts of series

	KM	KML	N	AN	KMK	KMFE	KMT
HNA 1-4	1 - 4		1 - 4		1 - 4	4	0 - 2
HNA 5-8	5 - 8		5 - 8		5 - 8	5 - 8	3 - 7
HNA 9-13	9 - 13		9 - 13		9 - 13	9 - 13	8 - 12
HNA 14-24	14 - 24	24		14 - 24	14 - 20	14 - 24	13 - 24

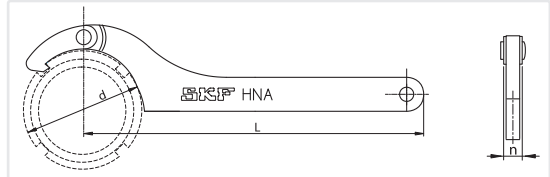

### TMFN series (page 14)

Designation	d		Dimensions f		L		Weight	
	mm	in	mm	in	mm	in	kg	lb
TMFN 23-30	150 - 195	5,9 - 7,7	11,5	0,45	200	7,9	1,1	2,4
TMFN 30-40	195 - 250	7,7 - 9,8	13,5	0,53	200	7,9	1,5	3,3
TMFN 40-52	250 - 320	9,8 - 12,6	17	0,67	340	13,4	3,2	7,0
TMFN 52-64	320 - 400	12,6 - 15,7	19	0,75	325	12,8	4,1	9,0
TMFN 64-80	400 - 520	15,7 - 20,5	23	0,91	310	12,2	4,3	9,5
TMFN 80-500	520 - 630	20,5 - 24,8	28	1,10	370	14,6	6,9	15,2
TMFN 500-600	630 - 750	24,8 - 29,5	36	1,42	350	13,8	8,5	18,7
TMFN 600-750	750 - 950	29,5 - 37,4	40	1,57	600	23,6	11,0	24,2

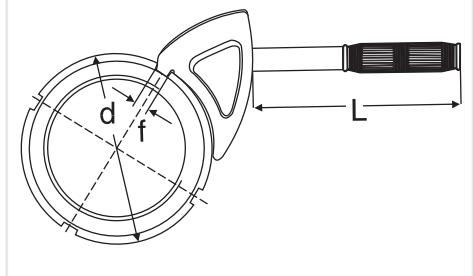

### TMFN series Selection chart

Designation	Suitable for adapter sleeves		Suitable for nuts of series						
	H 23, H 31 H 32	H 30 H 39	KM	KML	HM T	HM	KMFE	KMT	DIN 1804 (M)
	sizes								
TMFN 23-30	24 - 30	26 - 32	23 - 30	26 - 32	-	-	23 - 26	24, 26-32	M105 x 2, M110 x 2
TMFN 30-40	30 - 40	34 - 40	31 - 40	34 - 40	-	-	-	34 - 40	-
TMFN 40-52	40 - 48	44 - 52	-	-	42T - 50T	3044 - 3052	-	-	-
TMFN 52-64	52 - 64	56 - 68	-	-	52T - 56T	3056 - 3068	-	-	-
TMFN 64-80	64 - 80	68 - 88	-	-	-	3168 - 3088	-	-	-
TMFN 80-500	80 - 500	88 - 530	-	-	-	3184 - 3196	-	-	-
TMFN 500-600	500 - 600	530 - 630	-	-	-	30/500 - 30/630	-	-	-
TMFN 600-750	600 - 750	670 - 800	-	-	-	31/600 - 31/750	-	-	-

### TMFS series (page 15)

Designation	Dimensions						Connection □ C	Weight		Suitable for nuts of series KM, KMK, KMF
	d		D		h			kg	lb	
TMFS 0	18	0,7	22,0	0,9	45	1,8	3/8	0,12	0,27	0
TMFS 1	22	0,9	28,0	1,1	45	1,8	3/8	0,12	0,27	1
TMFS 2	25	1,0	33,0	1,3	61	2,4	1/2	0,22	0,49	2
TMFS 3	28	1,1	36,0	1,4	61	2,4	1/2	0,23	0,51	3
TMFS 4	32	1,3	38,0	1,5	58	2,3	1/2	0,26	0,58	4
TMFS 5	38	1,5	46,0	1,8	58	2,3	1/2	0,34	0,75	5
TMFS 6	45	1,8	53,0	2,1	58	2,3	1/2	0,39	0,86	6
TMFS 7	52	2,0	60,0	2,4	58	2,3	1/2	0,45	1,00	7
TMFS 8	58	2,3	68,0	2,7	58	2,3	1/2	0,51	1,13	8
TMFS 9	65	2,6	73,5	2,9	63	2,5	3/4	0,89	1,97	9
TMFS 10	70	2,8	78,5	3,1	63	2,5	3/4	0,79	1,75	10
TMFS 11	75	3,0	83,5	3,3	63	2,5	3/4	0,87	1,92	11
TMFS 12	80	3,1	88,5	3,5	63	2,5	3/4	1,40	3,09	12
TMFS 13	85	3,3	94,0	3,7	63	2,5	3/4	1,40	3,09	13
TMFS 14	92	3,6	103,0	4,1	80	3,2	1	1,92	4,24	14
TMFS 15	98	3,9	109,0	4,3	80	3,2	1	1,92	4,02	15
TMFS 16	105	4,1	116,0	4,6	80	3,2	1	1,83	4,04	16
TMFS 17	110	4,3	121,0	4,8	80	3,2	1	1,83	4,04	17
TMFS 18	120	4,7	131,0	5,2	80	3,2	1	3,60	7,94	18
TMFS 19	125	4,9	137,0	5,5	80	3,2	1	3,05	6,73	19
TMFS 20	130	5,1	143,0	5,7	80	3,2	1	3,30	7,28	20

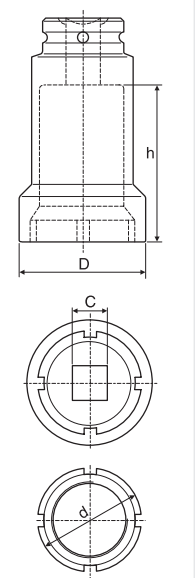

# Technical data

## HN /SNL series (page 14)

<b>Designation</b>	<b>HN **/SNL</b>
<b>Description</b>	Special hook spanner for use with SNL housings
<b>Material</b>	Black phosphated, hardened chrome vanadium steel
<b>Suitable</b>	SKF SNL and SNH housings KM, KML, N, AN, KMK, KMFE and KMT lock nuts

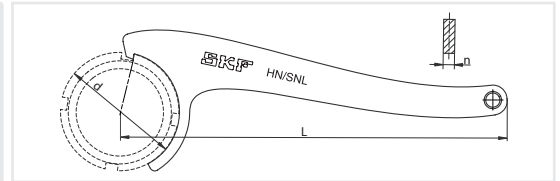

Designation	d – outer diameter locknut		L – working length		n – thickness		weight	
	mm	in	mm	in	mm	in	g	lb
HN 5/SNL	38	1,50	175	6,9	5	0,20	100	0,22
HN 6/SNL	45	1,77	210	8,3	6	0,24	176	0,39
HN 7/SNL	52	2,05	210	8,3	6	0,24	180	0,40
HN 8/SNL	58	2,28	245	9,6	7	0,28	280	0,62
HN 9/SNL	65	2,56	245	9,6	7	0,28	295	0,65
HN 10/SNL	70	2,76	245	9,6	7	0,28	310	0,68
HN 11/SNL	75	2,95	245	9,6	7	0,28	330	0,73
HN 12/SNL	80	3,15	280	11,0	8	0,31	455	1,00
HN 13/SNL	85	3,35	280	11,0	8	0,31	484	1,07
HN 15/SNL	98	3,86	280	11,0	8	0,31	490	1,08
HN 16/SNL	105	4,13	325	12,8	10	0,39	780	1,72
HN 17/SNL	110	4,33	325	12,8	10	0,39	826	1,82
HN 18/SNL	120	4,72	325	12,8	10	0,39	826	1,82
HN 19/SNL	125	4,92	325	12,8	10	0,39	865	1,91
HN 20/SNL	130	5,12	325	12,8	10	0,39	875	1,93
HN 22/SNL	145	5,71	375	14,8	12	0,47	1260	2,78
HN 24/SNL	155	6,10	375	14,8	12	0,47	1352	2,98
HN 26/SNL	165	6,50	375	14,8	12	0,47	1395	3,08
HN 28/SNL	180	7,09	445	17,5	14	0,55	2175	4,80
HN 30/SNL	195	7,68	445	17,5	14	0,55	2281	5,03
HN 32/SNL	210	8,27	445	17,5	14	0,55	2486	5,48

## HN /SNL series Selection chart

	Suitable for SKF housings SNL	Suitable for SKF nuts of series						
		KM	KML	N*	AN*	KMK*	KMFE*	KMT*
HN 5/SNL	505, 506 – 605	5		5		5	5	5
HN 6/SNL	506 – 605, 507 – 606	6		6		6	6	6
HN 7/SNL	507 – 606, 508 – 607	7		7		7	7	7
HN 8/SNL	508 – 607, 510 – 608	8		8		8	8	8
HN 9/SNL	509, 511 – 609	9		9		9	9	9
HN 10/SNL	510 – 608, 512 – 610	10		10		10	10	10
HN 11/SNL	511 – 609, 513 – 611	11		11		11	11	11
HN 12/SNL	512 – 610, 515 – 612	12		12		12	12	12
HN 13/SNL	513 – 611, 516 – 613	13		13		13	13	13
HN 15/SNL	515 – 612, 518 – 615	15			15	15	15	15
HN 16/SNL	516 – 613, 519 – 616	16			16	16	16	16
HN 17/SNL	517, 520 – 617	17			17	17	17	17
HN 18/SNL	518 – 615	18			18	18	18	18
HN 19/SNL	519 – 616, 522 – 619	19			19	19	19	19
HN 20/SNL	520 – 617, 524 – 620	20			20	20	20	20
HN 22/SNL	522 – 619	22	24		22	22	22	22
HN 24/SNL	524 – 620	24	26		24	24	24	24
HN 26/SNL	526	26	28				26	26
HN 28/SNL	528	28	30		28			
HN 30/SNL	530	30	32		30			
HN 32/SNL	532	32						32

\* Not recommended in combination with SNL/SNH housing

## TMBH 1 (page 17)

<b>Designation</b>	<b>TMBH 1</b>		
<b>Power:</b>	100 – 240 V, 50 – 60 Hz	<b>Dimensions:</b>	150 × 330 × 105 mm (6 × 13 × 4 in)
<b>Voltage</b>	350 Watt	<b>Control box</b>	114 × 114 mm (4,5 × 4,5 in)
<b>Power (maximum)</b>	> 0,95	<b>Heating clamp</b>	52 × 52 mm (2,0 × 2,0 in)
<b>Cosine φ</b>		<b>Operating space heating clamp</b>	370 × 240 × 130 mm (15 × 9 × 5 in)
<b>Component size range:</b>		<b>Complete unit in carrying case</b>	75 cm (30 in)
– inner diameter	20 ... 100 mm (0,8 ... 4 in)	<b>Length clamp cable</b>	2 m (80 in)
– width	< 50 mm (2 in)	<b>Length power cable</b>	100 cm (40 in)
– weight	up to approximately 5 kg (11 lb)	<b>Length temperature probe cable</b>	4,5 kg (10 lb)
<b>Control functions:</b>		<b>Weight complete unit</b>	
<b>Time control</b>	0 – 60 minutes		
<b>Temperature control</b>	0 – 200 °C (32 – 392 °F)		
<b>Accuracy temperature control</b>	± 3 °C (6 °F)		
<b>Maximum temperature</b>	200 °C (392 °F)		

**729659 C** (page 17)

<b>Designation</b>	<b>729659 C</b> <b>729659 C/110V</b>		<b>Height of cover</b>	50 mm (2 in)
<b>Voltage</b>	729659 C	230V (50/60Hz)	<b>Overall dimensions (l × w × h)</b>	400 × 240 × 130 mm (16 × 10 × 5 in)
<b>Power</b>	729659 C/110V	115V (50/60Hz)	<b>Weight</b>	4,7 kg (10 lb)
<b>Temperature range</b>	1 000 W		<b>Length of connection cable</b>	2 metres (6,6 ft) (earth connection required)
<b>Plate dimensions (l × w)</b>	50 – 200 °C (120 – 390 °F)			
	380 × 178 mm (15 × 7 in)			

**TIH ...m series** (page 18-20)

<b>Designation</b>	<b>TIH 030M</b>	<b>TIH 100M</b>	<b>TIH 210M / TIH 210F</b>
<b>SKF m<sub>20</sub> performance</b>	28 kg (61,7 lb)	97 kg (213 lb)	210 kg (460 lb)
<b>Voltage, V/Hz</b>	230V/50 – 60Hz or 110V/50 – 60Hz	230V/50-60Hz or 400-460V/50-60Hz	Self-adjusting; 400/50 – 460/60
<b>Work piece:</b>			
– Maximum weight	40 kg (88 lb)	120 kg (264 lb)	300 kg (660 lb)
– Maximum bore diameter	20 – 300 mm (0,8 – 11,8 in)	20 – 400 mm (0,8 – 15,7 in)	60 – 600 mm (2,4 – 24 in)
<b>Temperature control:</b>			
– Range	0 – 250 °C (32 – 482 °F)	0 – 250 °C (32 – 482 °F)	0 – 250 °C (32 – 482 °F)
– Magnetic probe	Yes, K-type	Yes, K-type	Yes, K-type
– Accuracy (electronics)	± 2 °C (± 3,6 °F)	± 2 °C (± 3,6 °F)	± 3 °C (± 5 °F)
<b>Time control:</b>			
– Range	0 – 60 minutes	0 – 60 minutes	0 – 60 minutes
– Accuracy	± 0,01 sec.	± 0,01 sec.	± 0,01 sec.
<b>Maximum temperature (approx.)</b>	400 °C (750 °F)	400 °C (750 °F)	400 °C (750 °F)
<b>Thermometer mode</b>	Yes	Yes	Yes
<b>Bearing mode</b>	Yes	Yes	Yes
<b>Power reduction</b>	2-step; 50 – 100%	2-step; 50 – 100%	4-step; 20 – 40 – 60 – 80%
<b>Demagnetisation according to SKF norms (automatic)</b>	Yes (<2 A/cm)	Yes (<2 A/cm)	Yes (<2 A/cm)
<b>Can heat sealed bearings</b>	Yes	Yes	Yes
<b>Can heat pre – greased bearings</b>	Yes	Yes	Yes
<b>Error guiding codes</b>	Yes	Yes	Yes
<b>Thermal overload protection</b>	Yes	Yes	Yes
<b>Maximum magnetic flux</b>	1,7 T	1,7 T	1,5 T
<b>Control panel</b>	Key board with LED in remote control	Key board with LED in remote control	Key board with LED
<b>Operating area (w × h)</b>	100 × 135 mm (3,9 × 5,3 in)	155 × 205 mm (6,1 × 8,0 in)	250 × 250 mm (9,8 × 9,8 in)
<b>Coil diameter</b>	95 mm (3,7 in)	110 mm (4,3 in)	135 mm (5,3 in)
<b>Dimensions (w × d × h)</b>	450 × 195 × 210 mm (17,7 × 7,6 × 8,2 in)	570 × 230 × 350 mm (22,4 × 9,0 × 13,7 in)	600 × 350 × 420 mm (24 × 13,7 × 16,5 in)
<b>Total weight, including yokes</b>	20,9 kg (46 lb)	42 kg (92 lb)	75 kg (165 lb)
<b>Maximum power consumption</b>	2,0 kVA	3,6 kVA (230V) 4,0-4,6 kVA (400-460V)	10,0 kVA
<b>Number of standard yokes</b>	3	3	2
<b>Standard yokes</b>	45 × 45 × 215 mm (1,7 × 1,7 × 8,4 in), for heating bearings with bore diameter of 65 mm (2,6 in) and larger 28 × 28 × 215 mm (1,1 × 1,1 × 8,4 in), for heating bearings with bore diameter of 40 mm (1,6 in) and larger 14 × 14 × 215 mm (0,5 × 0,5 × 8,4 in), for heating bearings with bore diameter of 20 mm (0,8 in) and larger	56 × 56 × 296 mm (2,2 × 2,2 × 11,7 in), for heating bearings with bore diameter of 80 mm (3,1 in) and larger 28 × 28 × 296 mm (1,1 × 1,1 × 11,7 in), for heating bearings with bore diameter of 40 mm (1,6 in) and larger 14 × 14 × 296 mm (0,6 × 0,6 × 11,7 in), for heating bearings with bore diameter of 20 mm (0,8 in) and larger	70 × 70 × 420 mm (2,8 × 2,8 × 16,5 in), for heating bearings with bore diameter of 100 mm (3,9 in) and larger 40 × 40 × 420 mm (1,6 × 1,6 × 16,5 in), for heating bearings with bore diameter of 60 mm (2,4 in) and larger
<b>Core cross section</b>	45 × 45 mm (1,7 × 1,7 in)	56 × 56 mm (2,2 × 2,2 in)	70 × 70 mm (2,8 × 2,8 in)
<b>Yoke storage</b>	Yes, foldable	Yes, foldable	Yes, internal
<b>Sliding arm</b>	No	No	Yes
<b>Swivel arm</b>	No	Yes, large yoke only	No
<b>Cooling fan</b>	No	No	Optional
<b>Housing material</b>	Steel and glass filled polyamide	Steel and glass filled polyamide	Aluminium
<b>Warranty period</b>	3 years	3 years	3 years

# Technical data

## TMMH series (page 15)

Designation	TMMH 300/500	TMMH 500/700
Bearing outer diameter D	300 – 500 mm (12 – 20 in)	500 – 700 mm (20 – 28 in)
Max. lifting weight	500 kg (1 100 lb)	500 kg (1 100 lb)
Weight	6,3 kg (14 lb)	6,3 kg (14 lb)

## TIH T1 (page 21)

Designation	TIH T1		
Width	50 cm (20 in)	Length	72 cm (28 in)
Height	74 cm (29 in)	Capacity	900 kg (1 934 lb)

## Drive-up Method: 729124 SRB, TMJL 100SRB and TMJL 50SRB (page 24)

Designation	729124 SRB	TMJL 100SRB	TMJL 50SRB
Max. pressure	100 MPa / 14 500 psi	100 MPa / 14 500 psi	50 MPa / 7 250 psi
Volume/stroke	0,5 cm <sup>3</sup> / 0,03 in <sup>3</sup>	1,0 cm <sup>3</sup> / 0,06 in <sup>3</sup>	3,5 cm <sup>3</sup> / 0,21 in <sup>3</sup>
Oil container capacity	250 cm <sup>3</sup> / 15 in <sup>3</sup>	800 cm <sup>3</sup> / 48 in <sup>3</sup>	2 700 cm <sup>3</sup> / 165 in <sup>3</sup>
Digital pressure gauge unit	MPa / psi	MPa / psi	MPa / psi

NOTE: All above pumps are complete with digital pressure gauge, high pressure hose and quick connect coupling.

## Ordering details

Designation	Description	Designation	Description
HMV ..E (e.g. HMV 54E)	Metric thread hydraulic nut	TMJG 100 D	Gauge only (MPa/psi)
HMVC ..E (e.g. HMVC 54E)	Inch thread hydraulic nut	TMCD 10R	Horizontal dial indicator (0 – 10 mm)
HMV ..E/A101 (e.g. HMV 54E/A101)	Unthreaded hydraulic nut	TMCD 5P	Vertical dial indicator (0 – 5 mm)
729124 SRB (for nuts ≤ HMV 54E)	Pump with digital gauge (MPa/psi)	TMCD 1/2R	Horizontal dial indicator (0 – 0,5 in)
TMJL 100SRB (for nuts ≤ HMV 92E)	Pump with digital gauge (MPa/psi)		
TMJL 50SRB (for nuts ≤ HMV 200E)	Pump with digital gauge (MPa/psi)		

## HMV E series (page 26 and 109)

Designation	HMV E	Recommended Pumps
Thread form		HMV 10E – HMV 54E
HMV 10E – HMV 40E	ISO 965/111-1980 tolerance class 6H	729124 / TMJL 100 / 728619 E / TMJL 50
HMV 41E – HMV 200E	ISO 2901-1977 tolerance class 7H	TMJL 100 / 728619 E / TMJL 50
Mounting fluid	LHMF 300	HMV 56E – HMV 92E
		728619 E / TMJL 50
		Quick connection nipple
		729832 A (included)

## Replacement parts

0-rings	Nut designation followed by /233983 e.g. HMV 10/233983	Other types available	
Ball plug	233950E	Inch series nuts	HMVC E series
Quick connection nipple	729832 A	Nuts without threads	HMV..E/A101

Special executions also available on request

## Ordering details and dimensions

Designation	Dimensions						Permitted piston displacement	Piston area	Weight
	G thread	d <sub>1</sub> mm	d <sub>2</sub> mm	d <sub>3</sub> mm	B mm	B <sub>1</sub> mm			
HMV 10E	M 50 × 1,5	50,5	104	114	38	4	5	2 900	2,70
HMV 11E	M 55 × 2	55,5	109	120	38	4	5	3 150	2,75
HMV 12E	M 60 × 2	60,5	115	125	38	5	5	3 300	2,80
HMV 13E	M 65 × 2	65,5	121	130	38	5	5	3 600	3,00
HMV 14E	M 70 × 2	70,5	127	135	38	5	5	3 800	3,20
HMV 15E	M 75 × 2	75,5	132	140	38	5	5	4 000	3,40
HMV 16E	M 80 × 2	80,5	137	146	38	5	5	4 200	3,70
HMV 17E	M 85 × 2	85,5	142	150	38	5	5	4 400	3,75
HMV 18E	M 90 × 2	90,5	147	156	38	5	5	4 700	4,00
HMV 19E	M 95 × 2	95,5	153	162	38	5	5	4 900	4,30
HMV 20E	M 100 × 2	100,5	158	166	38	6	5	5 100	4,40
HMV 21E	M 105 × 2	105,5	163	172	38	6	5	5 300	4,65
HMV 22E	M 110 × 2	110,5	169	178	38	6	5	5 600	4,95
HMV 23E	M 115 × 2	115,5	174	182	38	6	5	5 800	5,00
HMV 24E	M 120 × 2	120,5	179	188	38	6	5	6 000	5,25
HMV 25E	M 125 × 2	125,5	184	192	38	6	5	6 200	5,35
HMV 26E	M 130 × 2	130,5	190	198	38	6	5	6 400	5,65
HMV 27E	M 135 × 2	135,5	195	204	38	6	5	6 600	5,90
HMV 28E	M 140 × 2	140,5	200	208	38	7	5	6 800	6,00
HMV 29E	M 145 × 2	145,5	206	214	39	7	5	7 300	6,50

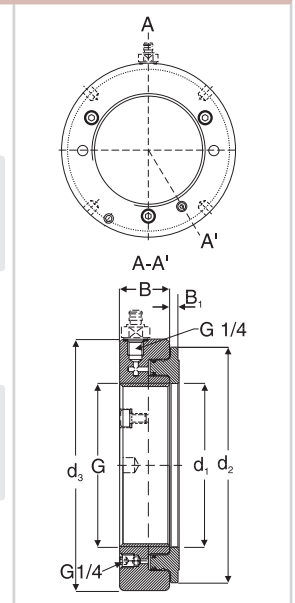

## Ordering details and dimensions

Designation							Permitted piston displacement mm	Piston area mm <sup>2</sup>	Weight kg
	G thread	d <sub>1</sub> mm	d <sub>2</sub> mm	d <sub>3</sub> mm	B mm	B <sub>1</sub> mm			
HMV 30E	M 150 × 2	150,5	211	220	39	7	5	7 500	6,60
HMV 31E	M 155 × 3	155,5	218	226	39	7	5	8 100	6,95
HMV 32E	M 160 × 3	160,5	224	232	40	7	6	8 600	7,60
HMV 33E	M 165 × 3	165,5	229	238	40	7	6	8 900	7,90
HMV 34E	M 170 × 3	170,5	235	244	41	7	6	9 400	8,40
HMV 36E	M 180 × 3	180,5	247	256	41	7	6	10 300	9,15
HMV 38E	M 190 × 3	191	259	270	42	8	7	11 500	10,5
HMV 40E	M 200 × 3	201	271	282	43	8	8	12 500	11,5
HMV 41E	Tr 205 × 4	207	276	288	43	8	8	12 800	12,0
HMV 42E	Tr 210 × 4	212	282	294	44	8	9	13 400	12,5
HMV 43E	Tr 215 × 4	217	287	300	44	8	9	13 700	13,0
HMV 44E	Tr 220 × 4	222	293	306	44	8	9	14 400	13,5
HMV 45E	Tr 225 × 4	227	300	312	45	8	9	15 200	14,5
HMV 46E	Tr 230 × 4	232	305	318	45	8	9	15 500	14,5
HMV 47E	Tr 235 × 4	237	311	326	46	8	10	16 200	16,0
HMV 48E	Tr 240 × 4	242	316	330	46	9	10	16 500	16,0
HMV 50E	Tr 250 × 4	252	329	342	46	9	10	17 600	17,5
HMV 52E	Tr 260 × 4	262	341	356	47	9	11	18 800	19,0
HMV 54E	Tr 270 × 4	272	352	368	48	9	12	19 800	20,5
HMV 56E	Tr 280 × 4	282	363	380	49	9	12	21 100	22,0
HMV 58E	Tr 290 × 4	292	375	390	49	9	13	22 400	22,5
HMV 60E	Tr 300 × 4	302	386	404	51	10	14	23 600	25,5
HMV 62E	Tr 310 × 5	312	397	416	52	10	14	24 900	27,0
HMV 64E	Tr 320 × 5	322	409	428	53	10	14	26 300	29,5
HMV 66E	Tr 330 × 5	332	419	438	53	10	14	27 000	30,0
HMV 68E	Tr 340 × 5	342	430	450	54	10	14	28 400	31,5
HMV 69E	Tr 345 × 5	347	436	456	54	10	14	29 400	32,5
HMV 70E	Tr 350 × 5	352	442	464	56	10	14	29 900	35,0
HMV 72E	Tr 360 × 5	362	455	472	56	10	15	31 300	35,5
HMV 73E	Tr 365 × 5	367	460	482	57	11	15	31 700	38,5
HMV 74E	Tr 370 × 5	372	466	486	57	11	16	32 800	39,0
HMV 76E	Tr 380 × 5	382	476	498	58	11	16	33 500	40,5
HMV 77E	Tr 385 × 5	387	483	504	58	11	16	34 700	41,0
HMV 80E	Tr 400 × 5	402	499	522	60	11	17	36 700	45,5
HMV 82E	Tr 410 × 5	412	510	534	61	11	17	38 300	48,0
HMV 84E	Tr 420 × 5	422	522	546	61	11	17	40 000	50,0
HMV 86E	Tr 430 × 5	432	532	556	62	11	17	40 800	52,5
HMV 88E	Tr 440 × 5	442	543	566	62	12	17	42 500	54,0
HMV 90E	Tr 450 × 5	452	554	580	64	12	17	44 100	57,5
HMV 92E	Tr 460 × 5	462	565	590	64	12	17	45 100	60,0
HMV 94E	Tr 470 × 5	472	576	602	65	12	18	46 900	62,0
HMV 96E	Tr 480 × 5	482	587	612	65	12	19	48 600	63,0
HMV 98E	Tr 490 × 5	492	597	624	66	12	19	49 500	66,0
HMV 100E	Tr 500 × 5	502	609	636	67	12	19	51 500	70,0
HMV 102E	Tr 510 × 6	512	624	648	68	12	20	53 300	74,0
HMV 104E	Tr 520 × 6	522	634	658	68	13	20	54 300	75,0
HMV 106E	Tr 530 × 6	532	645	670	69	13	21	56 200	79,0
HMV 108E	Tr 540 × 6	542	657	682	69	13	21	58 200	81,0
HMV 110E	Tr 550 × 6	552	667	693	70	13	21	59 200	84,0
HMV 112E	Tr 560 × 6	562	678	704	71	13	22	61 200	88,0
HMV 114E	Tr 570 × 6	572	689	716	72	13	23	63 200	91,0
HMV 116E	Tr 580 × 6	582	699	726	72	13	23	64 200	94,0
HMV 120E	Tr 600 × 6	602	721	748	73	13	23	67 300	100
HMV 126E	Tr 630 × 6	632	754	782	74	14	23	72 900	110
HMV 130E	Tr 650 × 6	652	775	804	75	14	23	76 200	115
HMV 134E	Tr 670 × 6	672	796	826	76	14	24	79 500	120
HMV 138E	Tr 690 × 6	692	819	848	77	14	25	84 200	127
HMV 142E	Tr 710 × 7	712	840	870	78	15	25	87 700	135
HMV 150E	Tr 750 × 7	752	883	912	79	15	25	95 200	146
HMV 160E	Tr 800 × 7	802	936	965	80	16	25	103 900	161
HMV 170E	Tr 850 × 7	852	990	1 020	83	16	26	114 600	181
HMV 180E	Tr 900 × 7	902	1 043	1 075	86	17	30	124 100	205
HMV 190E	Tr 950 × 8	952	1 097	1 126	86	17	30	135 700	218
HMV 200E	Tr 1000 × 8	1 002	1 150	1 180	88	17	34	145 800	239

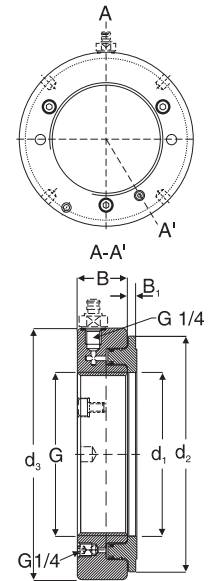

### 729124 (page 29)

Designation	729124		
Maximum pressure	100 MPa (14,500 psi)	Length of pressure hose	1 500 mm (59 in)
Volume/stroke	0,5 cm <sup>3</sup> (0,03 in <sup>3</sup> )	Connection nipple	G 1/4 quick connection
Oil container capacity	250 cm <sup>3</sup> (15 in <sup>3</sup> )	Weight	3,5 kg (8 lb)



# Technical data

## HMVC E series (page 26 and 109)

<b>Designation</b>	<b>HMVC E</b>		
<b>Thread form</b>	<b>HMVC 10E – HMVC 64E</b>		
	American National Form Threads Class 3		
<b>HMVC 68E – HMVC 190E</b>	ACME General Purpose Threads Class 3 G		
<b>Mounting fluid</b>	LHM 300		
	<b>Recommended Pumps</b>	729124 / TMJL 100 / 728619 E / TMJL 90	
	<b>HMVC 10E – HMVC 52E</b>	TMJL 100 / 728619 E / TMJL 50	
	<b>HMVC 56E – HMVC 92E</b>	728619 E / TMJL 50	
	<b>HMVC 94E – HMVC 190E</b>	729832 A (included)	
	<b>Quick connection nipple</b>		

## Ordering details and dimensions

Designation	Pitch diameter		Threads per in				Permitted piston displacement		Piston area	Weight	
	G	in		d <sub>1</sub>	d <sub>2</sub>	d <sub>3</sub>	B	B <sub>1</sub>			
	in	in	–	in	in	in	in	in	in <sup>2</sup>	lb	
HMVC 10E	1 967	1 9309	18	2,0	4,1	4,5	1,5	0,16	0,20	4,5	6,0
HMVC 11E	2 157	2 1209	18	2,2	4,3	4,7	1,5	0,16	0,20	4,9	6,1
HMVC 12E	2 360	2 3239	18	2,4	4,5	4,9	1,5	0,20	0,20	5,1	6,2
HMVC 13E	2 548	2 5119	18	2,6	4,8	5,1	1,5	0,20	0,20	5,6	6,6
HMVC 14E	2 751	2 7149	18	2,8	5,0	5,3	1,5	0,20	0,20	5,9	7,1
HMVC 15E	2 933	2 8789	12	3,0	5,2	5,5	1,5	0,20	0,20	6,2	7,5
HMVC 16E	3 137	3 0829	12	3,2	5,4	5,7	1,5	0,20	0,20	6,5	8,2
HMVC 17E	3 340	3 2859	12	3,4	5,6	5,9	1,5	0,20	0,20	6,8	8,3
HMVC 18E	3 527	3 4729	12	3,6	5,8	6,1	1,5	0,20	0,20	7,3	8,8
HMVC 19E	3 730	3 6759	12	3,8	6,0	6,4	1,5	0,20	0,20	7,6	9,5
HMVC 20E	3 918	3 8639	12	4,0	6,2	6,5	1,5	0,24	0,20	7,9	9,7
HMVC 21E	4 122	4 0679	12	4,2	6,4	6,8	1,5	0,24	0,20	8,2	10,3
HMVC 22E	4 325	4 2709	12	4,4	6,7	7,0	1,5	0,24	0,20	8,7	10,9
HMVC 24E	4 716	4 6619	12	4,7	7,0	7,4	1,5	0,24	0,20	9,3	11,6
HMVC 26E	5,106	5 0519	12	5,1	7,5	7,8	1,5	0,24	0,20	9,9	12,5
HMVC 28E	5 497	5 4429	12	5,5	7,9	8,2	1,5	0,28	0,20	10,5	13,2
HMVC 30E	5 888	5 8339	12	5,9	8,3	8,7	1,5	0,28	0,20	11,6	14,6
HMVC 32E	6 284	6 2028	8	6,3	8,8	9,1	1,6	0,28	0,24	13,3	16,8
HMVC 34E	6 659	6 5778	8	6,7	9,3	9,6	1,6	0,28	0,24	14,6	18,5
HMVC 36E	7 066	6 9848	8	7,1	9,7	10,1	1,6	0,28	0,24	16,0	20,2
HMVC 38E	7 472	7 3908	8	7,5	10,2	10,6	1,7	0,31	0,28	17,8	23,1
HMVC 40E	7 847	7 7658	8	7,9	10,7	11,1	1,7	0,31	0,31	19,4	25,4
HMVC 44E	8 628	8 5468	8	8,7	11,5	12,0	1,7	0,31	0,35	22,3	29,8
HMVC 48E	9 442	9 3337	6	9,5	12,4	13,0	1,8	0,35	0,39	25,6	35,3
HMVC 52E	10 192	10 0837	6	10,3	13,4	14,0	1,9	0,35	0,43	29,1	41,9
HMVC 56E	11 004	10 8957	6	11,1	14,3	15,0	1,9	0,35	0,47	32,7	48,5
HMVC 60E	11 785	11 6767	6	11,9	15,2	15,9	2,0	0,39	0,55	36,6	56,2
HMVC 64E	12 562	12 4537	6	12,7	16,1	16,9	2,1	0,39	0,55	40,8	65,0
HMVC 68E	13 339	13 2190	5	13,5	16,9	17,7	2,1	0,39	0,55	44,0	69,4
HMVC 72E	14 170	14 0500	5	14,3	17,9	18,6	2,2	0,39	0,59	48,5	78,3
HMVC 76E	14 957	14 8370	5	15,0	18,7	19,6	2,3	0,43	0,63	51,9	89,3
HMVC 80E	15 745	15 6250	5	15,8	19,6	20,6	2,4	0,43	0,67	56,9	100
HMVC 84E	16 532	16 4120	5	16,6	20,6	21,5	2,4	0,43	0,67	62,0	110
HMVC 88E	17 319	17 1990	5	17,4	21,4	22,3	2,4	0,47	0,67	65,9	119
HMVC 92E	18 107	17 9870	5	18,2	22,2	23,3	2,5	0,47	0,67	69,9	132
HMVC 96E	18 894	18 7740	5	19,0	23,1	24,1	2,6	0,47	0,75	75,3	139
HMVC 100E	19 682	19 5620	5	19,8	24,0	25,0	2,6	0,47	0,75	79,8	154
HMVC 106E	20 867	20 7220	4	20,9	25,4	26,4	2,7	0,51	0,83	87,1	174
HMVC 112E	22 048	21 9030	4	22,1	26,7	27,7	2,8	0,51	0,87	94,9	194
HMVC 120E	23 623	23 4780	4	23,7	28,4	29,4	2,9	0,51	0,91	104,3	220
HMVC 126E	24 804	24 6590	4	24,9	29,7	30,8	2,9	0,55	0,91	113,0	243
HMVC 134E	26 379	26 2340	4	26,5	31,3	32,5	3,0	0,55	0,94	123,2	265
HMVC 142E	27 961	27 7740	3	28,0	33,1	34,3	3,1	0,59	0,98	135,9	298
HMVC 150E	29 536	29 3490	3	29,6	34,8	35,9	3,1	0,59	0,98	147,6	322
HMVC 160E	31 504	31 3170	3	31,6	36,9	38,0	3,1	0,63	0,98	161,0	355
HMVC 170E	33 473	33 2860	3	33,5	39,0	40,2	3,3	0,63	1,02	177,6	399
HMVC 180E	35 441	35 2540	3	35,5	41,1	42,3	3,4	0,67	1,18	192,4	452
HMVC 190E	37 410	37 2230	3	37,5	43,2	44,3	3,4	0,67	1,18	210,3	481

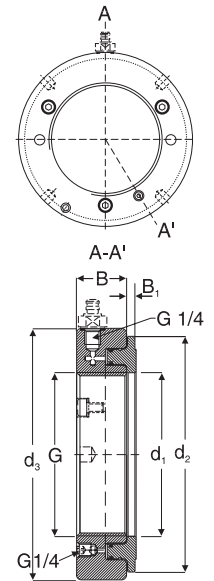

## TMEM 1500 (page 27)

<b>Designation</b>	<b>TMEM 1500</b>		
<b>Range of measurement</b>	0 to 1,500 o/oo	<b>Operating temperature range</b>	-10 °C to 50 °C (14 °F to 122 °F)
<b>Power supply</b>	9-volt alkaline battery, type IEC 6LR61	<b>Accuracy</b>	+/- 1%, +/- 2 digits
<b>Battery life</b>	8 hours, continuous use	<b>IP rating</b>	IP 40
<b>Low battery warning</b>	Display shows "batt"	<b>Weight</b>	250 g (8,75 oz.)
<b>Auto shut-off</b>	After 30 minutes of inactivity	<b>Size</b>	157 × 84 × 30 mm (6,1 × 3,3 × 1,8 in)
<b>Display</b>	4-digit LCD with fixed decimal		

## HMV E/A101 series (page 26 and 109)

<b>Designation</b>	<b>HMV E/A101</b>		
<b>Mounting fluid</b>	LHMF 300	<b>HMV 54E/A101 – HMV 92E/A101</b>	TMJL 100 / 728619 E/ TMJL 50
<b>Recommended Pumps</b>		<b>HMV 94E/A101 – HMV 200E/A101</b>	728619 E/ TMJL 50
<b>HMV 10E/A101 – HMV 52E/A101</b>	729124 / TMJL 100 / 728619 E/ TMJL 50	<b>Quick connection nipple</b>	729832 A (included)

## Ordering details and dimensions

Designation	Bore diameter G		Designation	Bore diameter G		Designation	Bore diameter G	
	mm	in		mm	in		mm	in
HMV 10E/A101	46,7	1,84	HMV 43E/A101	210,2	8,28	HMV 94E/A101	464,7	18,30
HMV 11E/A101	51,1	2,01	HMV 44E/A101	215,2	8,47	HMV 96E/A101	474,7	18,69
HMV 12E/A101	56,1	2,21	HMV 45E/A101	220,2	8,67	HMV 98E/A101	484,7	19,08
HMV 13E/A101	61,1	2,41	HMV 46E/A101	225,2	8,87	HMV 100E/A101	494,7	19,48
HMV 14E/A101	66,1	2,60	HMV 47E/A101	230,2	9,06	HMV 102E/A101	503,7	19,83
HMV 15E/A101	71,1	2,80	HMV 48E/A101	235,2	9,26	HMV 104E/A101	513,7	20,22
HMV 16E/A101	76,1	3,00	HMV 50E/A101	245,2	9,65	HMV 106E/A101	523,7	20,62
HMV 17E/A101	81,1	3,19	HMV 52E/A101	255,2	10,05	HMV 108E/A101	533,7	21,01
HMV 18E/A101	86,1	3,39	HMV 54E/A101	265,2	10,44	HMV 110E/A101	543,7	21,41
HMV 19E/A101	91,1	3,59	HMV 56E/A101	275,2	10,83	HMV 112E/A101	553,7	21,80
HMV 20E/A101	96,1	3,78	HMV 58E/A101	285,2	11,23	HMV 114E/A101	563,7	22,19
HMV 21E/A101	101,1	3,98	HMV 60E/A101	295,2	11,62	HMV 116E/A101	573,7	22,59
HMV 22E/A101	106,1	4,18	HMV 62E/A101	304,7	12,00	HMV 120E/A101	593,7	23,37
HMV 23E/A101	111,1	4,37	HMV 64E/A101	314,7	12,39	HMV 126E/A101	623,7	24,56
HMV 24E/A101	116,1	4,57	HMV 66E/A101	324,7	12,78	HMV 130E/A101	643,7	25,34
HMV 25E/A101	121,1	4,77	HMV 68E/A101	334,7	13,18	HMV 134E/A101	663,7	26,13
HMV 26E/A101	126,1	4,96	HMV 69E/A101	339,7	13,37	HMV 138E/A101	683,7	26,92
HMV 27E/A101	131,1	5,16	HMV 70E/A101	344,7	13,57	HMV 142E/A101	702,7	27,67
HMV 28E/A101	136,1	5,36	HMV 72E/A101	354,7	13,96	HMV 150E/A101	742,7	29,24
HMV 29E/A101	141,1	5,56	HMV 73E/A101	359,7	14,16	HMV 160E/A101	792,7	31,21
HMV 30E/A101	146,1	5,75	HMV 74E/A101	364,7	14,36	HMV 170E/A101	842,7	33,18
HMV 31E/A101	149,8	5,90	HMV 76E/A101	374,7	14,75	HMV 180E/A101	892,7	35,15
HMV 32E/A101	154,8	6,09	HMV 77E/A101	379,7	14,95	HMV 190E/A101	941,7	37,07
HMV 33E/A101	159,8	6,29	HMV 80E/A101	394,7	15,54	HMV 200E/A101	991,7	39,04
HMV 34E/A101	164,8	6,49	HMV 82E/A101	404,7	15,93			
HMV 36E/A101	174,8	6,88	HMV 84E/A101	414,7	16,33			
HMV 38E/A101	184,8	7,28	HMV 86E/A101	424,7	16,72			
HMV 40E/A101	194,8	7,67	HMV 88E/A101	434,7	17,11			
HMV 41E/A101	200,2	7,88	HMV 90E/A101	444,7	17,51			
HMV 42E/A101	205,2	8,08	HMV 92E/A101	454,7	17,90			

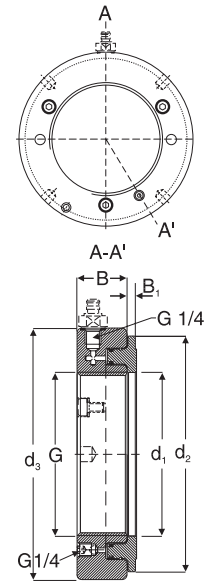

## Feeler gauges 729865 series (page 27)

Designation	Blade length		Blade thickness		in		mm		in
	mm	in	mm	mm	in	mm	mm		
729865 A	100	4,0	0,03	0,0012	0,08	0,0031	0,14	0,0055	
			0,04	0,0016	0,09	0,0035	0,15	0,0059	
			0,05	0,0020	0,10	0,0039	0,20	0,0079	
			0,06	0,0024	0,12	0,0047	0,30	0,0118	
			0,07	0,0028					
729865 B	200	8,0	0,05	0,0020	0,18	0,0071	0,60	0,0236	
			0,09	0,0035	0,19	0,0075	0,65	0,0256	
			0,10	0,0039	0,20	0,0079	0,70	0,0276	
			0,11	0,0043	0,25	0,0098	0,75	0,0295	
			0,12	0,0047	0,30	0,0118	0,80	0,0315	
			0,13	0,0051	0,35	0,0138	0,85	0,0335	
			0,14	0,0055	0,40	0,0157	0,90	0,0354	
			0,15	0,0059	0,45	0,0177	0,95	0,0374	
			0,16	0,0063	0,50	0,0197	1,00	0,0394	
			0,17	0,0067	0,55	0,0216			

## TMJL 100 (page 29)

<b>Designation</b>	<b>TMJL 100</b>
<b>Maximum pressure</b>	100 MPa (14,500 psi)
<b>Volume/stroke</b>	1,0 cm <sup>3</sup> (0,06 in <sup>3</sup> )
<b>Oil container capacity</b>	800 cm <sup>3</sup> (48 in <sup>3</sup> )
<b>Length of pressure hose</b>	3 000 mm (118 in)
<b>Connection nipple</b>	G 1/4 quick connection
<b>Weight</b>	13 kg (29 lb)

## TMJL 50 (page 30)

<b>Designation</b>	<b>TMJL 50</b>
<b>Maximum pressure</b>	50 MPa (7 250 psi)
<b>Volume/stroke</b>	3,5 cm <sup>3</sup> (0,21 in <sup>3</sup> )
<b>Oil container capacity</b>	2 700 cm <sup>3</sup> (165 in <sup>3</sup> )
<b>Length of pressure hose</b>	3 000 mm (118 in)
<b>Connection nipple</b>	G 1/4 quick connection
<b>Weight</b>	12 kg (26 lb)

# Technical data

## 728619 E (page 30)

<b>Designation</b>	<b>728619 E</b>		
<b>Maximum pressure</b>	150 MPa (21 750 psi)	<b>Oil container capacity</b>	2 550 cm <sup>3</sup> (155 in <sup>3</sup> )
<b>Volume/stroke 1st Stage</b>	20 cm <sup>3</sup> below 2,5 MPa (1,2 in <sup>3</sup> below 362 psi)	<b>Length of pressure hose</b>	3 000 mm (118 in)
<b>Volume/stroke 2nd Stage</b>	1 cm <sup>3</sup> above 2,5 MPa (0,06 in <sup>3</sup> above 362 psi)	<b>Connection nipple</b>	G 1/4 quick connection 11,4 kg (25 lb)

## THAP series (page 31)

Designation	Nominal hydraulic pressure	Pressure ratio	Maximum air pressure	Volume/stroke	Oil outlet	Length	Height	Width	Weight
THAP 030	30 MPa 4 350 psi	1 : 59	0,7 MPa 101,5 psi	6,63 cm <sup>3</sup> 0,40 in <sup>3</sup>	G 3/4	380 mm 15 in	190 mm 7,5 in	120 mm 4,7 in	21 kg 46,2 lb
THAP 030/SET	Complete set consisting of pump, high pressure hose and connecting nipples.								23 kg 50,7 lb
THAP 150	150 MPa 21 750 psi	1 : 252	0,7 MPa 101,5 psi	1,09 cm <sup>3</sup> 0,06 in <sup>3</sup>	G 3/4	330 mm 13,0 in	190 mm 7,5 in	120 mm 4,7 in	19 kg 41,8 lb
THAP 150/SET	Complete set consisting of pump, pressure gauge, adapter block, high pressure hose and connecting nipples.								24 kg 52,9 lb
THAP 300E	300 MPa 43 500 psi	1 : 500	0,7 MPa 101,5 psi	0,84 cm <sup>3</sup> 0,05 in <sup>3</sup>	G 3/4	405 mm 16 in	202 mm 8 in	171 mm 6,7 in	24,5 kg 54 lb
THAP 300E/SET	Complete set consisting of pump, pressure gauge, high pressure pipe.								24,5 kg 54 lb
THAP 400E	400 MPa 58 000 psi	1 : 600	0,7 MPa 101,5 psi	0,65 cm <sup>3</sup> 0,039 in <sup>3</sup>	G 3/4	405 mm 16 in	202 mm 8 in	171 mm 6,7 in	13 kg 28,6 lb
THAP 400E/SET	Complete set consisting of pump, pressure gauge, high pressure pipe								24,5 kg 54 lb

## 226270 and 226271 (page 31)

Injector	226270	226271
Valve nipple (optional)	226272	226273
Suitable shaft diameters	100 mm (4 in)	200 mm (8 in)
Maximum pressure	300 MPa (43 500 psi)	300 MPa (43 500 psi)
Oil container capacity	5,5 cm <sup>3</sup> (0,33 in <sup>3</sup> )	25 cm <sup>3</sup> (1,5 in <sup>3</sup> )
Connecting threads	G 3/8	G 3/4
Load to reach max. pressure	10 kg (22 lb)	30 kg (66 lb)
Weight	0,8 kg (1,8 lb)	2,1 kg (4,6 lb)

## Valve nipple

Designation	Dimensions													
	G	A		A <sub>1</sub>	F		F <sub>1</sub>	L		N				
	mm	in	mm	in	mm	in	mm	in	mm	in	mm	in		
226272	G 3/8	15	0,59	17	0,67	9	0,35	10	0,39	40	1,57	25,4	1,00	
226273	G 3/4	20	0,79	22	0,87	14	0,55	15	0,59	50	1,97	36,9	1,45	
	<b>Width across flats</b>				<b>Weight</b>									
	mm	in		kg	lb									
226272	22	0,87		0,05	0,11									
226273	32	1,26		0,20	0,44									

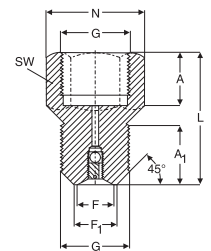

## TMJE series (page 33)

Injector set	TMJE 300	TMJE 400
Maximum pressure	300 MPa (43 500 psi)	400 MPa (58 000 psi)
Handle force at max. pressure	300 N (67,5 lbf)	400 N (90 lbf)
Volume per stroke	0,23 cm <sup>3</sup> (0,014 in <sup>3</sup> )	0,23 cm <sup>3</sup> (0,014 in <sup>3</sup> )
Oil container capacity	200 cm <sup>3</sup> (12,2 in <sup>3</sup> )	200 cm <sup>3</sup> (12,2 in <sup>3</sup> )
Weight	8 kg (18 lb)	8 kg (18 lb)
Pressure gauge	1077589	1077589/2
High pressure pipe	227957 A	227957 A/400MPa

## 226400 series (page 32)

Designation	226400	226400/400MPa
Maximum pressure	300 MPa (43,500 psi)	400 MPa (58,000 psi)
Volume /stroke	0,23 cm <sup>3</sup> (0,014 in <sup>3</sup> )	0,23 cm <sup>3</sup> (0,014 in <sup>3</sup> )
Oil container capacity	200 cm <sup>3</sup> (12,2 in <sup>3</sup> )	200 cm <sup>3</sup> (12,2 in <sup>3</sup> )
Connecting threads	G 3/4	G 3/4
Weight	2,2 kg (5 lb)	2,2 kg (5 lb)

## 226402 (page 33)

Designation	226402
Maximum pressure	400 MPa (58,000 psi)
Pressure gauge connection	G 1/2
Pressure pipe connection	G 3/4
Length of floor support	570 mm (22,4 in)
Weight	2,65 kg (6 lb)

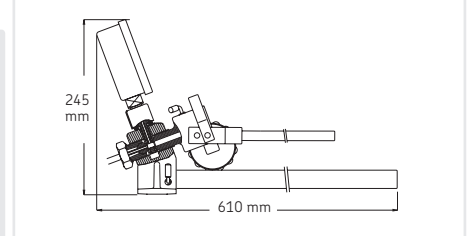

## High pressure pipes (page 34)

Maximum working pressure	300 MPa (43 500 psi)	Outer pipe diameter	4 mm (0,16 in)
Test pressure	400 MPa (58 000 psi)	Inner pipe diameter	2 mm (0,08 in)
Test quantity	100%	Pipe lengths	Between 300 mm (12 in) and 4 000 mm (118 in) can be ordered e.g. 227957A/3000 (3000 mm long)

## Ordering details and dimensions

Designation	Dimensions												Weight	
	G <sub>1</sub>	G	A		A <sub>1</sub>		D <sub>w</sub>		D <sub>w1</sub>		L		kg	lb
	-	-	mm	in	mm	in	mm	in	mm	in	mm	in		
721740 A	G 3/4	G 1/8	11,5	0,45	36,9	1,45	7,94	0,31	15,88	0,63	1 000	39	0,3	0,7
227957 A*	G 3/4	G 1/4	17,3	0,68	36,9	1,45	11,11	0,44	15,88	0,63	2 000	78	0,4	0,9
227958 A*	G 3/4	G 3/4	36,9	1,45	36,9	1,45	15,88	0,63	15,88	0,63	2 000	78	0,6	1,3
1020612 A**	G 1/4	G 1/4	17,3	0,68	17,3	0,68	11,11	0,44	11,11	0,44	1 000	39	0,5	1,1
728017 A	G 1/4	G 1/4	17,3	0,68	17,3	0,68	11,11	0,44	7,94	0,31	300	12	0,2	0,4
727213 A***	G 1/4	G 1/4	17,3	0,68	17,3	0,68	7,94	0,31	7,94	0,31	300	12	0,2	0,4
729123 A	G 3/4	G 1/4	17,3	0,68	36,9	1,45	7,94	0,31	15,88	0,63	300	12	0,3	0,7

\* These pipes are also available in a 400 MPa execution. Designations are 227957 A/400MP and 227958 A/400MP. Outer diameter of the pipe is 6 mm (0,24 in)

\*\* Maximum pressure 400 MPa (58 000 psi). Outer diameter of the pipe 6 mm (0,24 in).

\*\*\* The high pressure pipe 727213 A is designed to fit small OK-couplings. This pipe is not suitable for normal oil injection connection holes.

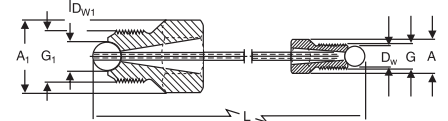

## Pressure gauges (page 34)

Designation	Pressure range		Diameter H		Connection thread	Weight		Accuracy % of full scale
	MPa	psi	mm	in		kg	lb	
1077587	0 - 100	0 - 14 500	100	3,94	G 1/2	0,80	1,8	1
1077587/2	0 - 100	0 - 14 500	63	2,48	G 1/4	0,25	0,6	1,6
TMJG 100D	0 - 100	0 - 15 000	76	3,00	G 1/4	0,21	0,5	<0,2
1077589	0 - 300	0 - 43 500	100	3,94	G 1/2	0,80	1,8	1
1077589/2	0 - 400	0 - 58 000	100	3,94	G 1/2	0,80	1,8	1

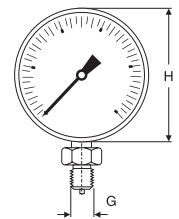

## Plugs for oil ducts and vent holes (page 34)

Designation	Thread	Length		Weight		Suitable hex. key	
		mm	in	kg	lb	mm	in
233950 E	G 1/4	15	0,59	0,02	0,04	6	0,24
729944 E	G 1/2	17	0,67	0,03	0,07	9	0,35
1030816 E	G 3/4	23	0,90	0,05	0,11	14	0,55

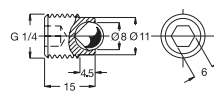

Plug 233950 E

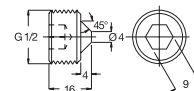

Plug 729944 E

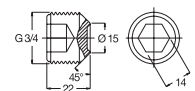

Plug 1030816 E

Maximum working pressure 400 MPa (58 000 psi)

# Technical data

## Flexible high pressure hoses (page 34)

Designation	Bore diameter		Outside diameter		Maximum working pressure		Minimum burst pressure		Minimum bending radius		End fittings	Working temperature		Length		Weight	
	mm	in	mm	in	MPa	psi	MPa	psi	mm	in		°C	°F	mm	in	kg	l
729126	4,0	0,16	10	0,39	100	14 500	300	43 500	65	2,6	G 1/4	-30/80	-22/176	1 500	59	0,4	0,9
729834	5,0	0,20	11	0,43	150	21 750	450	65 250	150	5,9	G 1/4	-30/80	-22/176	3 000	118	0,9	2,0

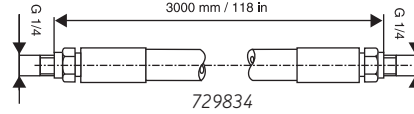
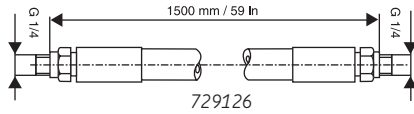

## Quick connection coupling and nipples (page 35)

Designation	Thread d <sub>2</sub>	Dimensions D <sub>2</sub>				C		A		Maximum pressure	
		mm	in	mm	in	mm	in	mm	in	MPa	psi
<b>Coupling</b>											
729831 A	G 1/4	24	0,94	27	1,06	58	2,28	150	21 750		
<b>Nipples</b>											
729832 A	G 1/4	22	0,87	14	0,55	46	1,81	150	21 750		
729100	G 1/8	17	0,67	14	0,55	43	1,69	100	14 500		

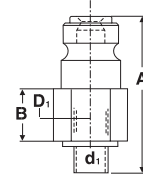

729832A  
729100

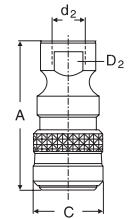

729831A

## Connection nipples with NPT tapered threads (page 35)

Designation	G	G <sub>2</sub>	Dimensions						Key width		Weight			
			A	G <sub>1</sub>	G <sub>3</sub>	L	mm	in	kg	lb				
729654	NPT 1/4"	G 1/4	25,4	1,00	15	0,59	15	0,59	42	1,65	22	0,87	0,25	0,55
729655	NPT 3/8"	G 1/4	25,4	1,00	15	0,59	15	0,59	40	1,57	22	0,87	0,25	0,55
729106	G 1/4	NPT 3/8"	36,9	1,45	17	0,67	15	0,59	50	1,97	32	1,26	0,16	0,35
729656	NPT 3/4"	G 1/4	36,9	1,45	20	0,79	15	0,59	45	1,77	32	1,26	0,30	0,66

Maximum working pressure 300 MPa (34,500 psi)

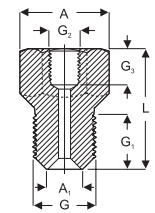

## Connection nipples with metric and G pipe threads (page 36)

Designation	G	G <sub>2</sub>	Dimensions A				A <sub>1</sub>		G <sub>1</sub>		G <sub>3</sub>		L	
			mm	in	mm	in	mm	in	mm	in	mm	in	mm	in
1077456	M 8	M 6	11	0,43	5	0,20	15	0,59	9	0,35	33	1,30		
1077455	G 1/8	M 6	11	0,43	7	0,28	15	0,59	9	0,35	33	1,30		
1014357 A	G 1/8	G 1/4	25,4	1,00	7	0,28	15	0,59	15	0,59	43	1,69		
1009030 B	G 1/8	G 3/8	25,4	1,00	7	0,28	15	0,59	15	0,59	42	1,65		
1019950	G 1/8	G 1/2	36,9	1,45	7	0,28	15	0,59	14	0,55	50	1,97		
1018219 E	G 1/4	G 3/8	25,4	1,00	9,5	0,37	17	0,67	15	0,59	45	1,77		
1009030 E	G 1/4	G 3/4	36,9	1,45	9,5	0,37	17	0,67	20	0,79	54	2,13		
1012783 E	G 3/8	G 1/4	25,4	1,00	10	0,39	17	0,67	15	0,59	43	1,96		
1008593 E	G 3/8	G 3/4	36,9	1,45	10	0,39	17	0,67	20	0,79	53	2,09		
1016402 E	G 1/2	G 1/4	25,4	1,00	14	0,55	20	0,79	15	0,59	43	1,96		
729146	G 1/2	G 3/4	36,9	1,45	-	-	17	0,67	20	0,79	50	1,97		
228027 E	G 3/4	G 1/4	36,9	1,45	15	0,59	22	0,87	15	0,59	50	1,97		

Designation	Width across flats		Weight	
	mm	in	kg	lb
1077456	10	0,39	0,05	0,11
1077455	10	0,39	0,05	0,11
1014357 A	22	0,87	0,06	0,13
1009030 B	22	0,87	0,06	0,13
1019950	32	1,26	0,14	0,31
1018219 E	22	0,87	0,07	0,15
1009030 E	32	1,26	0,13	0,29
1012783 E	22	0,87	0,08	0,18
1008593 E	32	1,26	0,15	0,33
1016402 E	22	0,87	0,10	0,22
729146	32	1,26	0,18	0,40
228027 E	32	1,26	0,25	0,55

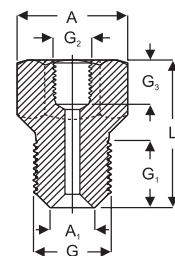

All nipples with E suffix have a maximum working pressure of 400 MPa (58 000 psi), otherwise maximum working pressure is 300 MPa (34 500 psi)

### Extension pipes with connection nipples (page 36)

#### M4 extension pipe with connection nipple (A)

Designation	pipe	234064	nipple	234063
Max. pressure	50 MPa (7 250 psi)		50 MPa (7 250 psi)	

#### M6 extension pipe with connection nipple (B)

Designation	pipe	1077453	nipple	1077454
Max. pressure	200 MPa (29 000 psi)		200 MPa (29 000 psi)	

#### Valve nipple with extension pipe (C)

Designation	pipe	227964	nipple	227963
Max. pressure	300 MPa (43 500 psi)		300 MPa (43 500 psi)	

#### Extension pipe (D)

Designation	227965			
Max. pressure	300 MPa (43 500 psi) Normally used in combination with high pressure pipe eg. 227957 A			

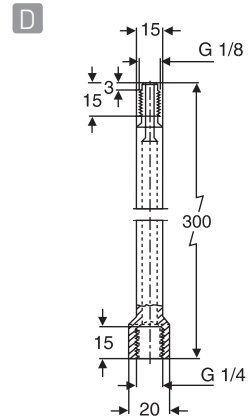
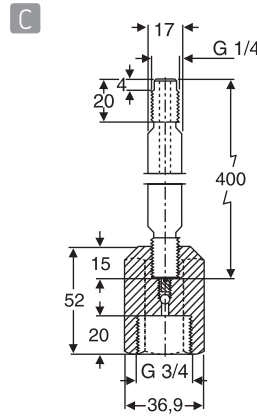
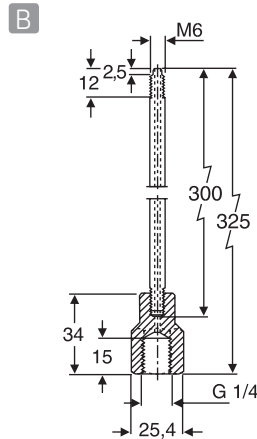
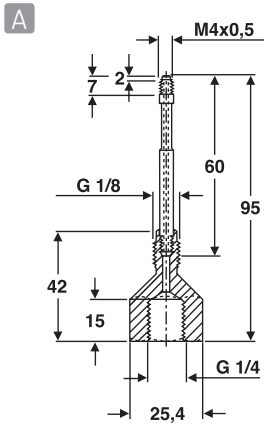

### TMBA G11W (page 38)

Designation	TMBA G11W
Size	9
Colour	White/blue
Pack size	1 pair

### TMBA G11 (page 38)

Designation	TMBA G11
Material	Hytex
Inner lining	Cotton
Size	9
Colour	White
Maximum temperature	150 °C (302 °F)
Pack size	1 pair

### TMBA G11ET (page 39)

Designation	TMBA G11ET
Material	KEVLAR®
Inner lining	Cotton
Size	10 (EN 420 size)
Colour	Yellow
Maximum temperature	500 °C (932 °F)
Pack size	1 pair

### TMBA G11H (page 39)

Designation	TMBA G11H
Material	Polyaramid
Inner lining	Nitrile
Size	10
Colour	Blue
Maximum temperature	250 °C (482 °F)
Pack size	1 pair

### TMEA P1 (page 46) (optional for TMEA 1P/2.5 and standard for TMEA 1PEX)

Printing system	Thermal dot matrix
Power	Rechargeable battery – 12V maximum, Continental European adaptor
Operation time	60 minutes continuous operation with fully charged battery

### Product and accessories ordering details

Designation	Description
TMEA 2	Shaft alignment tool
TMEA 1P/2.5	Shaft alignment tool with printer capability
TMEA 1PEX	Intrinsically safe shaft alignment with printer
TMEA P1	Thermal printer complete with Continental European adaptor and connection cable (TMEA 1P/2.5 and TMEA 1PEX only)
TMEA C2	Extension chain set (1 020 mm / 40,1 in)
TMEA F2	1 × non magnetic fixture, chain and 220 mm (8,6 in) rod
TMEA F6	2 thin chain fixtures, complete set
TMEA F7	Set of 3 pairs of connection rods; short: 150 mm (5,9 in), medium: 220 mm (8,6 in) and long: 320 mm (12,5 in)
TMEA MF	1 magnetic fixture
TMEA P1-10	UK / Australian mains adaptor for the printer
TMEA R1	3 spare rolls of thermal paper for the printer

# Technical data

## TMEA series (page 44 – 45)

Designation	TMEA 2	TMEA 1/P2.5	TMEA 1PEX
<b>Measuring units:</b>			
Type of laser	Diode laser	Diode laser	Diode laser
Laser wave length	670 – 675 nm	670 – 675 nm	670 – 675 nm
Laser class	2	2	2
Maximum laser power	1 mW	1 mW	1 mW
Maximum distance between measuring units	0,850 m (2,8 ft)	2,50 m (8,2 ft)	1 m (3 ft)
Type of detectors	Single axis PSD, 8,5 × 0,9 mm (0,3 × ,04 in)	Single axis PSD, 10 × 10 mm (0,4 × ,04 in)	Single axis PSD, 10 × 10 mm (0,4 × ,04 in)
Fixture	Magnetic and/or chain	Chain standard	Chain standard
		Magnetic optional	Magnetic optional
<b>Display unit:</b>			
Battery type	2 × 1,5V LR14 Alkaline	3 × 1,5V LR14 Alkaline	Special type of LR 14 batteries
Operating time	20 hours continuous operation	20 hours continuous operation	20 hours continuous operation
Displayed resolution	0,01 mm (0,1 mil in "inch" setting)	0,01 mm (0,1 mil in "inch" setting)	0,01 mm (0,1 mil in "inch" setting)
<b>Complete system:</b>			
Content	Display unit 2 measuring units with spirit levels 2 magnetic / mechanical shaft fixtures 2 locking chains 5 sets of shims Measuring tape Instructions for use Set of alignment reports Carrying case	Display unit 2 measuring units with spirit levels 2 mechanical shaft fixtures 2 locking chains 2 extension chains 5 sets of shims Measuring tape Instructions for use Set of alignment reports Carrying case	Display unit 2 measuring units with spirit levels 2 mechanical shaft fixtures 2 locking chains 2 extension chains 5 sets of shims Measuring tape Instructions for use Set of alignment reports Carrying case Printer Charger Connection cable Spare paper roll
<b>Shaft diameter range</b>	Magnetic: 40 – 500 mm (1,6 – 20 in) Chain: 40 – 150 mm (1,6 – 5,9 in) Optional chain: 150 – 500 mm (5,9 – 20 in)	30 – 500 mm (1,2 – 20 in)	30 – 500 mm (1,2 – 20 in)
<b>Accuracy of system</b>	Better than 2%	Better than 2%	Better than 2%
<b>Ex classification</b>	–	–	II 2 G, EEx ib IIC T4
<b>Ex certificate number</b>	–	–	Nemko03ATEX101X
<b>Temperature range</b>	0 – 40 °C (32 – 104 °F)	0 – 40 °C (32 – 104 °F) without printer	0 – 40 °C (32 – 104 °F) without printer
<b>Operating humidity</b>	< 90 %	< 90 % without printer	< 90 % without printer
<b>Carrying case dimensions</b>	390 × 340 × 95 mm (15,4 × 13,4 × 3,7 in)	534 × 427 × 157 mm (21,0 × 16,8 × 6,2 in)	534 × 427 × 157 mm (21,0 × 16,8 × 6,2 in)
<b>Total weight (incl. case)</b>	3,7 kg (8,1 lb)	8,9 kg (19,6 lb)	8,9 kg (19,6 lb)
<b>Calibration certificate</b>	Valid for two years	Valid for two years	Valid for two years
<b>Warranty</b>	12 months	12 months	12 months
<b>Printing capability</b>	No	Yes – printer is optional	Yes – printer is standard

## TMEB 2 (page 48)

Designation	TMEB 2		
<b>Content</b>	1 laser unit 1 receiver unit 4 set of V guides Carrying case	<b>Dimensions laser unit</b>	70 × 74 × 61 mm (2,8 × 2,9 × 2,4 in)
<b>Housing material</b>	Extruded aluminium	<b>Dimensions receiver unit</b>	96 × 74 × 61 mm (3,8 × 2,9 × 2,4 in)
Type of laser	Diode laser, class 2, 1 mW	<b>Battery type</b>	2 × 1,5V LR03 (AAA) batteries in laser unit
Laser wave length	632 nm	<b>Battery lifetime</b>	20 hours continuous operation
Measurement distance	50 mm to 6,000 mm (2 in to 20 ft)	<b>Weight laser unit</b>	320 g (11,3 oz)
Fixture	Magnetic	<b>Weight receiver unit</b>	270 g (9,5 oz)
Measurement accuracy angular	Better than 0,2°	<b>Calibration certificate</b>	Valid for two years
Measurement accuracy linear	Better than 0,5 mm	<b>Warranty</b>	12 months

## Accessory ordering details

Designation	Description
TMEB A2	2 × magnetic side adaptor for chain sprocket, multi-ribbed and timing belt pulleys
TMEB G2	Set of V-guides, 4 different sizes

**TMAS series** (page 46-47)

Designation	Number of shims per set	A	B	C	Thickness	Designation	Number of shims per set	A	B	C	Thickness
		mm	mm	mm	mm			mm	mm	mm	mm
TMAS 50-005	10	50	50	13	0,05	TMAS 75-005	10	75	75	21	0,05
TMAS 50-010	10	50	50	13	0,10	TMAS 75-010	10	75	75	21	0,10
TMAS 50-020	10	50	50	13	0,20	TMAS 75-020	10	75	75	21	0,20
TMAS 50-025	10	50	50	13	0,25	TMAS 75-025	10	75	75	21	0,25
TMAS 50-040	10	50	50	13	0,40	TMAS 75-040	10	75	75	21	0,40
TMAS 50-050	10	50	50	13	0,50	TMAS 75-050	10	75	75	21	0,50
TMAS 50-070	10	50	50	13	0,70	TMAS 75-070	10	75	75	21	0,70
TMAS 50-100	10	50	50	13	1,00	TMAS 75-100	10	75	75	21	1,00
TMAS 50-200	10	50	50	13	2,00	TMAS 75-200	10	75	75	21	2,00
TMAS 50-300	10	50	50	13	3,00	TMAS 75-300	10	75	75	21	3,00
TMAS 100-005	10	100	100	32	0,05	TMAS 125-005	10	125	125	45	0,05
TMAS 100-010	10	100	100	32	0,10	TMAS 125-010	10	125	125	45	0,10
TMAS 100-020	10	100	100	32	0,20	TMAS 125-020	10	125	125	45	0,20
TMAS 100-025	10	100	100	32	0,25	TMAS 125-025	10	125	125	45	0,25
TMAS 100-040	10	100	100	32	0,40	TMAS 125-040	10	125	125	45	0,40
TMAS 100-050	10	100	100	32	0,50	TMAS 125-050	10	125	125	45	0,50
TMAS 100-070	10	100	100	32	0,70	TMAS 125-070	10	125	125	45	0,70
TMAS 100-100	10	100	100	32	1,00	TMAS 125-100	10	125	125	45	1,00
TMAS 100-200	10	100	100	32	2,00	TMAS 125-200	10	125	125	45	2,00
TMAS 100-300	10	100	100	32	3,00	TMAS 125-300	10	125	125	45	3,00
TMAS 200-005	10	200	200	55	0,05						
TMAS 200-010	10	200	200	55	0,10						
TMAS 200-020	10	200	200	55	0,20						
TMAS 200-025	10	200	200	55	0,25						
TMAS 200-040	10	200	200	55	0,40						
TMAS 200-050	10	200	200	55	0,50						
TMAS 200-070	10	200	200	55	0,70						
TMAS 200-100	10	200	200	55	1,00						
TMAS 200-200	10	200	200	55	2,00						
TMAS 200-300	10	200	200	55	3,00						

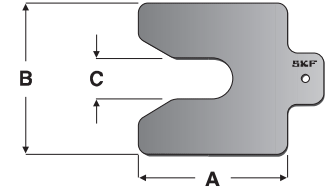
**Kits of single slot shims** (metric)

Designation	Contents	Weight
TMAS 340	340 shims in 9 thicknesses and 2 sizes	17 kg (37,4 lb)
TMAS 360	360 shims in 6 thicknesses and 3 sizes	12 kg (26,4 lb)
TMAS 510	510 shims in 9 thicknesses and 3 sizes	14 kg (30,8 lb)
TMAS 720	720 shims in 9 thicknesses and 4 sizes	30 kg (66 lb)

**LAGD series** (page 66 – 68)

<b>Grease capacity</b>	<b>LAGD 125</b> 125 ml (4,25 fl oz. US) <b>LAGD 60</b> 60 ml (2,03 fl oz. US)	
<b>Nominal emptying time</b>	Adjustable; 1 – 12 months	<b>Intrinsically safe approval</b>
<b>Ambient temperature range</b>	–20 to 60 °C (–5 to 140 °F)	II 1GD EEx ia IIC T6 T85°C I M1 EEx ia I
<b>Maximum operating pressure</b>	5 bar (75 psi)	<b>EC Type Examination Certificate</b>
<b>Drive mechanism</b>	Gas cell producing inert gas	Kema04ATEX1275X
<b>Connection thread</b>	G 1/4	<b>Protection class</b>
<b>Maximum feed line length with:</b>		<b>Recommended storage temperature</b>
– grease	300 mm (11,8 in)	20 °C (70 °F)
– oil	1 500 mm (59,1 in)	<b>Storage life of lubricator</b>
		2 years
		<b>Weight</b>
		LAGD 125 approx 200 g (7,1 oz)
		LAGD 60 approx 130 g (4,6 oz)
		Lubricant included

**LAGD 400** (page 71)

Designation	LAGD 400	
<b>Content</b>	8–outlet lubricator 20 m tubing Quick connectors for application side 2 Y-connectors LGMT 2/0.4 grease cartridge SKF's DialSet program	<b>Volume</b>
<b>Number of feed lines</b>	1 – 8	0,1 – 10 cm <sup>3</sup> /day (0,003 – 0,35 US fl. oz/day) per outlet approx 0,6 – 65 g/week (0,02 – 2,3 oz/week)
<b>Maximum pressure</b>	40 bar (600 psi)	<b>Power</b>
<b>Suitable grease</b>	NLGI 1, 2 and 3	110–240V AC, 50–60Hz or 24V DC
<b>Maximum length of feed-lines</b>	5 m (16 ft)	<b>Alarms</b>
<b>Ambient temperature</b>	0 – 50 °C (32 – 120 °F)	Blocked feed lines, empty cartridge; internal and external External relay steering
<b>Drive mechanism</b>	Electro-mechanical	<b>External steering</b>
		<b>IP rating</b>
		54
		<b>Lubrication tubes</b>
		20 m (65 ft), Nylon, 6 × 1,5 mm (1/4 × 0,06 in)
		<b>Connection thread</b>
		G 1/4
		<b>Height</b>
		530 mm (21 in)



# Technical data

Bearing greases (page 60 – 66)	LGMT 2	LGMT 3	LGEP 2	LGLT 2	LGHP 2	LGFP 2
<b>DIN 51825 code</b>	K2K-30	K3K-30	KP2G-20	KP2G-50	K2N-40	K2G-20
<b>NLGI consistency class</b>	2	3	2	2	2-3	2
<b>Soap type</b>	Lithium	Lithium	Lithium	Lithium complex	Di-urea	Aluminium
<b>Colour</b>	Red brown	Amber	Light brown	Beige	Blue	Transparent
<b>Base oil type</b>	Mineral	Mineral	Mineral	PAO	Mineral	Medical white oil
<b>Operating temperature range, °C (°F)</b>	-30 to 120 (-22 to 250)	-30 to 120 (-22 to 250)	-20 to 110 (-4 to 230)	-50 to 110 (-58 to 230)	-40 to 150 (-40 to 300)	-20 to 110 (-4 to 230)
<b>Dropping point DIN ISO 2176, °C (°F)</b>	180 min. (356 min.)	180 min. (356 min.)	180 min. (356 min.)	180 min. (356 min.)	240 min. (464 min.)	250 min. (482 min.)
<b>Base oil viscosity:</b> 40 °C, mm <sup>2</sup> /s 100 °C, mm <sup>2</sup> /s	110 11	120-130 12	200 16	18 4,5	96 10,5	130 7,3
<b>Penetration DIN ISO 2137:</b> 60 strokes, 10 <sup>-1</sup> mm 100 000 strokes, 10 <sup>-1</sup> mm	265 – 295 +50 max. (325 max.)	220 – 250 280 max.	265 – 295 +50 max. (325 max.)	265 – 295 +50 max.	245 – 275 365 max.	265 – 295 +30 max.
<b>Mechanical stability:</b> Roll stability, 50 hrs at 80 °C, 10 <sup>-1</sup> mm SKF V2F test	+ 50 max. 'M'	295 max. 'M'	+50 max. 'M'	+380 max. –	365 max. –	– –
<b>Corrosion protection:</b> SKF Emcor: – standard ISO 11007 – water washout test – salt water test (100% seawater)	0 – 0 0 – 0 0 – 1*	0 – 0 0 – 0 –	0 – 0 0 – 0 1 – 1*	0 – 1 – –	0 – 0 0 – 0 0 – 0	0 – 0 – –
<b>Water resistance</b> DIN 51 807/1, 3 hrs at 90 °C	1 max.	2 max.	1 max.	1 max.	1 max.	1 max.
<b>Oil separation</b> DIN 51 817, 7 days at 40 °C, static, %	1 – 6	1 – 3	2 – 5	<4	1 – 5	1 – 5
<b>Lubrication ability</b> SKF R2F, running test B at 120 °C	Pass	Pass	Pass	–	Pass	–
<b>Copper corrosion</b> DIN 51 811, 110 °C	2 max. (130 °C / 266 °F)	2 max.	2 max. (100 °C)	1 max. (150 °C / 300 °F)	1 max.	–
<b>Rolling bearing grease life</b> SKF R0F test L50 life at 10 000 rpm, hrs	– –	1000 min. at 130 °C (266 °F)	– – at 100 °C (212 °F)	> 1 000, 20 000 rpm	1 000 min. at 150 °C (302 °F)	1 000 at 110 °C (230 °F)
<b>EP performance</b> Wear scar DIN 51350/5, 1 400 N, mm 4-ball test, welding load DIN 51350/4	– –	– –	1,4 max 2 800 min.	– 2 000 min	– –	– 1 100 min.
<b>Fretting corrosion</b> ASTM D4170 (mg)	–	–	5,7 *	–	7 *	–
<b>Available pack sizes</b>	35, 200 g tube 420 ml cart. 1, 5, 18, 50, 180 kg –	– 420 ml cart. 1, 5, 18, 50, 180 kg –	– 420 ml cart. 1, 5, 18, 50, 180 kg –	200 g tube – 1, 25, 180 kg –	– 420 ml cart. 1, 5, 18, 50, 180 kg SYSTEM 24	– 420 ml cart. 1, 18, 180 kg SYSTEM 24
<b>Designation</b>	LGMT 2/ (pack size)	LGMT 3/ (pack size)	LGEP 2/ (pack size)	LGLT 2/ (pack size)	LGHP 2/ (pack size)	LGFP 2/ (pack size)

\* Typical value

Bearing greases (page 60 – 66)	LGGB 2	LGWA 2	LGHB 2	LGET 2	LGEM 2	LGEV 2	LGWM 1
<b>DIN 51825 code</b>	KPE 2K-40	KP2N-30	KP2N-20	KFK2U-40	KPF2K-20	KPF2K-10	KP1G-30
<b>NLGI consistency class</b>	2	2	2	2	2	2	1
<b>Soap type</b>	Lithium / calcium	Lithium complex	Complex calcium sulphionate	PTFE	Lithium	Lithium-calcium	Lithium
<b>Colour</b>	Off white	Amber	Brown	Whitish cream	Black	Black	brown
<b>Base oil type</b>	Synthetic ester	Mineral	Mineral	Synthetic (fluorinated polyether)	Mineral	Mineral	Mineral
<b>Operating temperature range, °C (°F)</b>	-40 to 120 (-40 to 250)	-30 to 140 (-22 to 284)	-20 to 150 (-4 to 300)	-40 to 260 (-40 to 500)	-20 to 120 (-4 to 250)	-10 to 120 (14 to 250)	-30 to 110 (-22 to 230)
<b>Dropping point DIN ISO 2176, °C (°F)</b>	>170 (>338)	> 250 (482)	>220 (>428)	> 300 (572)	>180 (356)	>180 (356)	>170 (338)
<b>Base oil viscosity:</b> 40 °C, mm <sup>2</sup> /s 100 °C, mm <sup>2</sup> /s	110 13	185 15	400 – 450 26,5	400 38	500 32	1020 58	200 16
<b>Penetration DIN ISO 2137:</b> 60 strokes, 10 <sup>-1</sup> mm 100 000 strokes, 10 <sup>-1</sup> mm	265 – 295 +50 max. (325 max.)	265 – 295 +50 max. (325 max.)	265 – 295 -20 – +50 (325 max.)	265 – 295 –	265 – 295 325 max.	265 – 295 325 max.	310 – 340 +50 max.
<b>Mechanical stability:</b> Roll stability, 50 hrs at 80 °C, 10 <sup>-1</sup> mm Roll stability, 72 hrs at 100 °C, 10 <sup>-1</sup> mm SKF V2F test	+70 max. (350 max.) – –	+50 max. change – 'M'	– -20 – +50 change 'M'	± 30 max. (130 °C/266 °F) – –	345 max. – 'M'	– +50 max. 'M'	– – –
<b>Corrosion protection:</b> SKF Emcor – standard ISO 11007 – water washout test – salt water test	0 – 0 – –	0 – 0 0 – 0 –	0 – 0 0 – 0 0 – 0*	1 – 1 – –	0 – 0 0 – 0 –	0 – 0 0 – 0* 0 – 0*	0 – 0 0 – 0 –
<b>Water resistance</b> DIN 51 807/1, 3 hrs at 90 °C	0 max.	1 max.	1 max.	0 max.	1 max.	1 max.	1 max.
<b>Oil separation</b> DIN 51 817, 7 days at 40 °C, static, %	0,8 – 3	1 – 5	1 – 3 (at 60 °C)	13 max. (30 hrs at 200 °C)	1 – 5	1 – 5	8 – 13
<b>Lubrication ability</b> SKF R2F, running test B	Pass at 100 °C* (212 °F)	Pass at 100 °C (212 °F)	Pass at 140 °C (284 °F)	–	Pass at 100 °C (212 °F)	–	–
<b>Copper corrosion</b> DIN 51 811, 100 °C	–	2 max. (150 °C/300 °F)	2 max. (150 °C/300 °F)	1	2 max.	1 max. (90 °C/194 °F)	2 max.
<b>Rolling bearing grease life</b> SKF R0F test L50 life at 10 000 rpm, hrs	> 300 at 120 °C (250 °F)	–	> 1000 at 130 °C (266 °F)	>700, 5600 rpm* at 220 °C (428 °F)	–	–	–
<b>EP performance</b> Wear scar DIN 51350/5, 1 400 N, mm 4-ball test, welding load DIN 51350/4	1,8 max. 2 600 min.	1,6 max. 2 600 min.	0,86* 4 800 N*	– 8 000 min.	1,4 max. 3 000 min.	1,2 max. 3 000 min.	1,8 max. 3 200 min.*
<b>Fretting corrosion</b> ASTM D4170 (mg)			0 *				5,5 *
<b>Available pack sizes</b>	– 420 ml cart. 5, 18, 180 kg SYSTEM 24	35, 200 g tube 420 ml cart. 1, 5, 50, 180 kg SYSTEM 24	– 420 ml cart. 5, 18, 50, 180 kg SYSTEM 24	50 g (25 ml) syringe 1 kg	– 420 ml cart. 5, 18, 180 kg SYSTEM 24	35 g tube 420 ml cart. 5, 18, 50, 180 kg	– 420 ml cart. 5, 50, 180 kg
<b>Designation</b>	LGGB 2/ (pack size)	LGWA 2/ (pack size)	LGHB 2/ (pack size)	LGET 2/ (pack size)	LGEM 2/ (pack size)	LGEV 2/ (pack size)	LGWM 1/ (pack size)

\* Typical value

# Technical data

Chemicals and oils LHRP 1 (page 38) LGAF 3E (page 10) LHMT 68, LHHT 265, LHFP 150 (page 69)					
	LHRP 1	LGAF 3E	LHMT 68	LHHT 265	LHFP 150
<b>Description</b>	Anti-corrosive agent	Anti-fretting paste	Medium temperature oil	High temperature oil	Food compatible, NSF H1 oil
<b>Specific gravity</b>	0,815	1,19	0,85	0,91	0,85
<b>Colour</b>	Hazy brown	White-beige	Yellow-brown	Yellow-orange	Colourless
<b>Base oil type</b>	Mineral	Mineral and synthetic	Mineral	Synthetic ester	Synthetic ester
<b>Thickener</b>	Not applicable	Lithium soap	Not applicable	Not applicable	Not applicable
<b>Operating temperature range, °C (°F)</b>	–	–25 to 250 °C (–13 to 482 °F)	–15 to 90 °C (5 to 194 °F)	Up to 250 °C (482 °F)	–30 to 120 °C (–22 to 248 °F)
<b>Base oil viscosity:</b> 20 °C, mm <sup>2</sup> /s 40 °C, mm <sup>2</sup> /s 100 °C, mm <sup>2</sup> /s	not valid because of thixotropic nature	– 17,5 –	– ISO VG 68 approx. 9	– approx. 265 approx. 30	– ISO VG 150 approx. 19
<b>Flash point</b>	39 °C (102 °F)	–	200 °C (392 °F)	approx. 260 °C (500 °F)	> 200 °C (392 °F)
<b>Pour point</b>	–20 °C (–4 °F)	–	–15 °C (5 °F)	–	< –30 °C (–22 °F)
<b>NSF approval</b>	Not applicable	Not applicable	Not applicable	Not applicable	H1 (No: 136858)
<b>Available pack sizes</b>	5 l can 180 l drum –	– 0,5 kg can –	125 ml automatic lubricator SYSTEM 24 400 ml aerosol can 5 l can	125 ml automatic lubricator SYSTEM 24 400 ml aerosol can 5 l can	125 ml automatic lubricator SYSTEM 24 400 ml aerosol can 5 l can
<b>Designation</b>	LHRP 1/ (pack size)	LAGF 3E/0,5	LAGD 125/HMT68 LHMT 68/ (packsize)	LAGD 125/HHT26 LHHT 265/ (packsize)	LAGD 125/HFP15 LHFP 150/ (packsize)

LAHD series (page 72)			
Designation	LAHD 500 / LAHD 1000		
<b>Boundary dimensions</b>			
– LAHD 500	Ø 91 mm × 290 mm high (3,6 × 11,4 in)	<b>Permissible humidity</b>	0 – 100 %
– LAHD 1000	Ø 122 mm × 290 mm high (4,8 × 11,4 in)	<b>Length of connecting tube</b>	600 mm (23,5 in)
<b>Reservoir volume</b>		<b>Connection thread</b>	G 1/2
– LAHD 500	500 ml (17 fl. oz. US)	<b>Tube material</b>	Polyurethane
– LAHD 1000	1 000 ml (34 fl. oz. US)	<b>O-ring material</b>	NBR – 70 Shore
<b>Container material</b>	Polycarbonate / aluminium	<b>Gaskets</b>	NBR – 80 Shore 6 pieces
<b>Allowed temperature range</b>	– 20 to 125 °C (–4 to 255 °F)	<b>Other material</b>	Aluminum, Bronze, Stainless Steel
		<b>Suitable oil types</b>	Mineral and synthetic oils

LAGP 400 (page 72)			
Designation	LAGP 400		
<b>Maximum volume per stroke</b>	20 cm <sup>3</sup> (1,2 in <sup>3</sup> )	<b>Length</b>	360 mm (14 in)
<b>Material</b>	steel and polyethylene	<b>Weight</b>	0,35 kg (0,77 lb)

1077600 (page 73)			
Designation	1077600		
<b>Maximum pressure</b>	40 MPa (5 800 psi)	<b>Length</b>	380 mm (14,9 in)
<b>Volume/stroke</b>	1,5 cm <sup>3</sup> (0,09 in <sup>3</sup> )	<b>Weight</b>	1,5 kg (3,3 lb)

LAGH 400 (page 73)			
Designation	LAGH 400		
<b>Maximum pressure</b>	30 MPa (4 350 psi)	<b>Length</b>	370 mm (14,6 in)
<b>Volume/stroke</b>	approx. 0,8 cm <sup>3</sup> (0,049 in <sup>3</sup> )	<b>Weight</b>	1,5 kg (3,3 lb)

**VKN 550** (page 74)

<b>Designation</b>	<b>VKN 550</b>		
<b>Description</b>	Bearing grease packer	<b>Other greases</b>	NLGI class 000 to 2
<b>Weight</b>	1,8 kg (3,9 lb)	<b>Bearing range</b>	
<b>Material</b>	Zinc plated, metal finish	– Inner diameter d	19 to 120 mm
<b>Suitable greases</b>	approved for all SKF greases	– Outer diameter D	Max 200 mm

**TMBA G11D** (page 74)

<b>Designation</b>	<b>TMBA G11D</b>		
<b>Pack size</b>	50 pairs		
<b>Size</b>	9		
<b>Colour</b>	white		

**LAGM 1000E** (page 74)

<b>Designation</b>	<b>LAGM 1000E</b>		
<b>Housing material</b>	Aluminium, anodised	<b>Accuracy</b>	±3% from 0 – 300 bar
<b>Weight</b>	0,3 kg (0,66 lb)		±5% from 300 – 700 bar
<b>IP rating</b>	IP 67	<b>Selectable units</b>	cm <sup>3</sup> , g, US fl. oz or oz
<b>Suitable greases</b>	NLGI 0 – NLGI 3	<b>Display lamp auto switch off</b>	15 seconds after last pulse
<b>Maximum operating pressure</b>	70 MPa (10 000 psi)	<b>Low battery</b>	Indication on display
<b>Maximum grease flow</b>	1 000 cm <sup>3</sup> /min (34 US fl. oz/min)	<b>Battery type</b>	1,5 V LR1 (2×) Alkaline
<b>Thread connections</b>	M10 × 1	<b>Unit auto switch off</b>	1 minute after last pulse
<b>Display</b>	Lit LCD (4 digits / 9 mm)		

**LAGF series** (page 75)

<b>Designation</b>	<b>LAGF 18</b>	<b>LAGF 50</b>
<b>Maximum pressure</b>	3 MPa (430 psi)	3 MPa (430 psi)
<b>Volume/stroke</b>	approx. 45 cm <sup>3</sup> (1,5 fl oz.)	approx. 45 cm <sup>3</sup> (1,5 fl oz.)
<b>Suitable drum dimensions:</b>		
– inside diameter	265 – 285 mm (10,4 – 11,2 in)	350 – 385 mm (13,8 – 15,2 in)
– maximum inside height	420 mm (16,5 in)	675 mm (26,6 in)
<b>Weight</b>	5 kg (11 lb)	7 kg (15 lb)

**LAGG series** (page 75)

<b>Designation</b>	<b>LAGG 18M</b>	<b>LAGG 18AE</b>	<b>LAGG 50AE</b>	<b>LAGG 180AE</b>	<b>LAGT 180</b>
<b>Description</b>	Grease pump for 18 kg drums	Mobile grease pump for 18 kg drums	Grease pump for 50 kg drums	Grease pump for 180 kg drums	Trolley for drums up to 200 kg
<b>Pumping</b>	Manual	Air–pressure	Air–pressure	Air–pressure	n.a.
<b>Max. pressure</b>	50 MPa (7 250 psi)	42 MPa (6 090 psi)	42 MPa (6 090 psi)	42 MPa (6 090 psi)	n.a.
<b>SKF Drum</b>	18 kg (39,6 lb)	18 kg (39,6 lb)	50 kg (110 lb)	180 kg (396 lb)	180 kg (396 lb)
<b>Inner diameter</b>	265 – 285 mm (10,43 – 11,22 in)	265 – 285 mm (10,43 – 11,22 in)	350 – 385 mm (13,78 – 15,16 in)	550 – 590 mm (21,65 – 23,23 in)	n.a.
<b>Note</b>	Stationary	Mobile	Stationary	Stationary	Mobile
<b>Volume/stroke</b>	1,6 cc	–	–	–	–
<b>Volume/min.</b>	–	200 cc	200 cc	200 cc	–

**LAGG 1M** (page 76)

<b>Designation</b>	<b>LAGG 1M</b>		
<b>Body pump material</b>	Polypropylene / Polyethylene, compatible with all SKF greases	<b>Suitable can dimensions</b>	105 – 108 mm (4,1 – 4,25 in)
<b>Follower plate material</b>	NBR, compatible with all SKF greases	<b>Inside diameter</b>	145 mm (5,7 in)
<b>Weight</b>	230 g (0,5 lb)	<b>Maximum inside height</b>	–
<b>Volume per stroke</b>	26 cm <sup>3</sup> (1,6 in <sup>3</sup> )	<b>Suitable greases consistencies</b>	NLGI 1 to 3

**LAGN 120** (page 76)

<b>Designation</b>	<b>LAGN 120</b>		
<b>Max working pressure</b>	40 MPa (5 800 psi)	<b>Standard Material</b>	DIN 71412
<b>Min burst pressure</b>	80 MPa (11 600 psi)		Hardened steel

# Technical data

## TMTP series (page 79)

<b>Designation</b>	<b>TMTP 200 / TMTP 200Ex</b>		
<b>Temperature range</b>	-40 to 200 °C (-40 to 392 °F)	<b>Switch off</b>	Button or automatic after 5 minutes
<b>Accuracy electronics</b>	≤ 0,5 °C (≤ 0,9 °F)	<b>Display indications</b>	Temperature, °C or °F, maximum temperature, out of range, defective probe, low battery
<b>Display resolution</b>	1 °C/°F	<b>IP rate</b>	IP 65
<b>Probe</b>	Integrated K-Type	<b>Drop resistance</b>	1 m (3,2 ft)
<b>Dimensions</b>	163 × 50 × 21 mm (6,4 × 2 × 0,8 in)	<b>Ex classification (TMTP 200Ex)</b>	II 1 GD EEx ia IIC T4 IP65
<b>Weight</b>	95 g (0,2 lb)	<b>Ambient temperature range</b>	0°C ... +50°C
<b>Battery</b>	3 × AAA (LR03) Only Duracell PC2400/MN2400 batteries are allowed for TMTP 200Ex	<b>EC Type Examination Certificate</b>	ISSEP02ATEX054X
<b>Average battery lifetime</b>	4 000 hours 2 000 hours (TMTP 200Ex)		

## Product ordering details

Designation	Description
TMTP 200	General purpose industrial thermometer
TMTP 200Ex	Intrinsically safe contact thermometer

## TMTL 500 (page 81)

<b>Designation</b>	<b>TMTL 500</b>		
<b>Temperature range</b>	-60 to 500 °C (-76 to 932 °F)	<b>Emissivity</b>	Pre-set 0,95
<b>Environmental limits</b>	Operation 0 to 50 °C (32 to 120 °F) 10 to 95% R.H. Storage -20 to 65 °C (-4 to 150 °C) 10 to 95% R.H.	<b>Laser wavelength</b>	635 - 650 nm
<b>Full range accuracy</b>	(Tamb = 23 +/- 3 °C) +/-2% of reading or 2 °C (whichever is greater)	<b>Laser</b>	Class 2
<b>Response time</b>	500 - 1000 msec	<b>Maximum laser power</b>	1 mW
<b>Display</b>	LCD	<b>Dimensions</b>	175 × 72 × 39 mm (6,9 × 2,8 × 1,5 in)
<b>Displayed resolution</b>	0,1 °C/F from -9,9-199,9, otherwise 1 °C/F	<b>Packed</b>	Carton box
<b>Distance to spot size</b>	11:1	<b>Weight</b>	180 g (0,4 lb)
<b>Spectral response</b>	8 - 14 μm	<b>Battery</b>	2 × AAA Alkaline type IEC LR03
<b>User selectable backlit display</b>	No, permanently on	<b>Battery lifetime</b>	18 hours
<b>User selectable laser pointer</b>	No, permanently on	<b>Switch off</b>	Automatic after 15 seconds after trigger is released
		<b>EMC standards</b>	EN 61326:1997+A1+A2
		<b>Laser standards</b>	CFR 1040-10 / 60825-1

## TMTL 1400K (page 82)

<b>Designation</b>	<b>TMTL 1400K</b>		
<b>Temperature range using infrared</b>	-60 to 500 °C (-76 to 932 °F)	<b>Alarm modes</b>	High and low level alarm level with warning bleep
<b>Temperature using probe</b>	-64 to 1 400 °C (-83 to 1 999 °F)	<b>Laser wavelength</b>	630 - 650 nm
<b>Probe supplied</b>	TMDT 2-30, suitable for use up to 900 °C (1650 °F)	<b>Laser</b>	Class 2
<b>Probe types suitable</b>	K type probes	<b>Maximum laser power</b>	1 mW
<b>Environmental limits</b>	Operation 0 to 50 °C (32 to 120 °F) 10 to 95% R.H. Storage -20 to 65 °C (-4 to 150 °C) 10 to 95% R.H.	<b>Dimensions</b>	175 × 72 × 39 mm (6,9 × 2,8 × 1,5 in)
<b>Full range accuracy</b>	(Tamb = 23 +/- 3 °C) +/-2% of reading or 2 °C (whichever is greater)	<b>Packed</b>	Sturdy carrying case
<b>Response time</b>	50 - 1 000 msec	<b>Case dimensions</b>	415 × 195 × 50 mm (16,3 × 7,7 × 2,0 in)
<b>Display</b>	LCD	<b>Weight</b>	940 g (2,1 lb)
<b>Displayed resolution</b>	0,1 °C/F from -9,9-199,9, otherwise 1 °C/F	<b>Battery</b>	2 × AAA Alkaline type IEC LR03
<b>Distance to spot size</b>	11:1	<b>Battery lifetime</b>	140 hours with laser and backlight off. Otherwise 18 hours
<b>Spectral response</b>	8 - 14 μm	<b>Switch off</b>	IR mode automatic after 60 seconds after trigger is released (60 minutes can be manually selected). Probe mode automatic after 12 minutes.
<b>Emissivity variable</b>	0,1 - 1,0	<b>EMC standards</b>	EN 61326:1997+A1+A2
<b>User selectable backlit display</b>	On/off	<b>Laser standards</b>	CFR 1040-10 / 60825-1
<b>User selectable laser pointer</b>	On/off		
<b>Measurement modes</b>	Max, min, average, differential, probe/ IR dual temperature modes		

## K-type thermocouple probes (page 82 - 83)

<b>Probe type</b>	K-type thermocouple (NiCr/NiAl) acc. IEC 584 Class 1	<b>Cable</b>	1 000 mm (39,4 in) spiral cable (excl. TMDT 2-31, -38, -39, 41)
<b>Accuracy</b>	± 1,5 °C (2,7 °F) up to 375 °C (707 °F) ± 0,4% of reading above 375 °C (707 °F)	<b>Plug</b>	K-type mini-plug (1 260-K)
<b>Handle</b>	110 mm (4,3 in) long		

**TMTI 300** (page 80)

Designation	TMTI 300				
<b>Performance</b>					
Temperature measurement range	-10 to 300 °C (14 to 572 °F)	<b>Included accessories</b>	Imager & handle Software for 'Pocket PC' & PC iPaq type synchronization cable 2m RS232 connection cable – imager to PC User manual AC power supply Tool case		
Field of view (FOV)	20° × 20°				
Spectral response	8 to 14 µm	<b>Computer requirements</b> <b>Pocket PC</b>	Compatible with most 'Pocket PC' devices running Microsoft 'Pocket PC' 2000, 2002 and 2003 RS 232 to 'Pocket PC' communication cable or CompactFlash RS 232 adaptor where applicable.		
Sensitivity	-0,3 K @ 30 °C (@ 102,2 °F)				
Displayed image	96 × 96 pixels on Pocket PC. 128 × 128 pixels on PC				
Detector	16 × 16 pixel array				
Frame rate	8 Hz				
Range	0,7m – infinity (2,29 ft – infinity)				
Image storage	Up to 1000 images per Mb of memory				
Laser pointer	Class II laser				
Imager power supply				<b>PC</b>	IBM compatible PC with a minimum of: 32Mb RAM, 300MHz processor, MS Windows (2000 and XP), RS 232 serial port (115k Baud), 16 bit colour graphics capability
Battery	4 × AA (LR6) alkaline batteries				
Operation time	Up to 8 hours				
AC operation	AC adaptor (supplied)				
<b>Mechanical</b>					
Housing	Impact resistant plastic				
Dimensions	120 × 125 × 80 mm (3,72 × 4,92 × 3,1 in)				
Weight	<600 g (21,16 oz) not including 'Pocket PC' and handle				
Mounting	Handheld & tripod mounting				
<b>Environment</b>					
Temp. operating range	-5 to 50 °C (23 to 122 °F)				
Humidity	10 % to 90 % non condensing				
Temp. storage range	-20 to 80 °C (-4 to 176 °F)				
CE Mark (Europe)	EMC DIRECTIVE 89/336/EEC as outlined in harmonized norm for Emission EN 50081-1, EN 55011 (B) Immunity EN 50082-2, EN 61000-4-2, -3, level 3.				
IP	40				
Laser conformance	USA 21, CFR 1040.10				

**TMRS 1** (page 85)

Designation	TMRS 1		
<b>Flash rate range</b>	40 – 12 500 flashes per minute (FPM)	<b>Battery charger AC input</b>	100 – 240 VAC, 50/60 Hz
Flash rate accuracy	+/- 0,5 FPM or +/- 0,01% of reading, whichever is greater		
Flash setting resolution	100 to 9999 FPM – 0,1FPM, 10 000 to 12 500 FPM -1FPM		
<b>Tachometer range</b>	40 – 59 000 RPM	<b>Display</b>	8 character by 2 line LCD, alphanumeric continuous
Tachometer accuracy	+/- 0,5 RPM or +/- 0,01% of reading, whichever is greater		
<b>Flash tube</b>	Xenon, 10W, TMRS 1-BULB	<b>Display update</b>	100 to 9 999 FPM – 0,1FPM, 10 000 to 12 500 FPM – 1FPM
Flash tube life	100 million flashes	<b>Display resolution</b>	Crystal oscillator, 100 ppm accuracy
Flash duration	9 – 15 µ sec	<b>Time base</b>	Power, × 2, ×1/2, phase shift, external trigger
Light power	154 mJ per flash	<b>Controls</b>	0 – 5V TTL type via stereo phono jack
Battery type	NiMH, rechargeable, removable	<b>External trigger input</b>	5 µ sec maximum
Battery capacity	2,6 AmpHr	<b>EXTL. trigger to flash delay</b>	Type signal via stereo phono jack
Battery charge time	2 – 4 hours, using supplied AC adaptor	<b>Clock output 0 – 5V TTL</b>	Grey
Run time per charge	2,5 hours at 1 600 FPM, 1,25 hours at 3 200 FPM	<b>Colour</b>	Impact & oil resistant polycarbonate
		<b>Housing</b>	650 g / 1 lb, 4 oz.
		<b>Weight</b>	10 °C to 40 °C (50 °F to 104 °F)
		<b>Operating temperature</b>	-20 °C to 45 °C (-4 °F to 113 °F)
		<b>Storage temperature</b>	

**TMES 1** (page 86)

Designation	TMES 1		
<b>Description</b>	Endoscope	<b>Light Source</b>	3,5V 0,7A 2,55W
Weight (case and contents)	1 135 g (2,5 lbs)		
Measurements (case size)	360 × 270 × 80 mm (14,1 × 10,6 × 3,1 in)	<b>Light type</b>	3 × C (LR 14) batteries
<b>Fibre</b>		<b>Power Supply</b>	
Fibre material	Acrylic	<b>Optical data</b>	
Number of pixels	3500	<b>Focal direction</b>	straight
Fibre strand diameter	35 µm (0,0014 in)	<b>Angle of view</b>	60°
Allowable ratio of fibre breakage	2% maximum	<b>Focal length</b>	10 mm (0,39 in) – ∞ (fixed focus)
<b>Cord</b>		<b>Water resistance</b>	Objective lens and fibre image tube is water resistant at an atmospheric pressure between 1 and 1,3 bar. Eye piece is not waterproof.
Fibre material	SUS304 coated with PVC		
Minimum bending radius	R 40 mm (1,6 in)	<b>Working temperature range</b>	-20 °C to 60 °C (-4 °F to 140 °F)

# Technical data

## TMRT series (page 84)

Designation	TMRT 1 / TMRT 1Ex		
Display	Inverting LCD Vertical 5 digit display	<b>Resolution range features</b>	Fully Auto ranging up to 0,001 digit or $\pm 1$ digit fixed, user selectable
Display functions	180° Inverting	<b>On target indicator</b>	Yes
Rotational speed range	Optical mode: 3 – 99,999 rpm (or equivalent in rps)	<b>Low battery indicator</b>	Yes
	Contact mode: Max. 50 000 rpm for 10 sec (or equivalent in rps)	<b>Memory features</b>	Last reading held for 1 minute Program settings retained in memory after power off After 1 minute
Linear speed range	0,30 – 1 500,0 Metres or Yds/min. (4 500 ft/min) or equivalent in seconds	<b>Auto switch off</b>	
Measurement modes	Optical; rpm and rps (also Count and Time) Via contact adaptor; rpm and rps, metres, yards, feet, per min and per sec. Count total revs, metres, feet, yards Measure Time interval in seconds between pulses (reciprocal rate) Speed Capture feature—Maximum, Minimum or Average rate	<b>Remote input for laser remote sensor TMRT 1-56</b>	Yes, TMRT 1 only
	50 mm – 2 000 mm (1,9 – 78,7 in)	<b>Contact adaptor</b>	Included complete with rpm cone and removable metric wheel assembly
Laser optical range	Minimum or Average rate	<b>Battery type TMRT 1</b>	4 × AAA alkaline cells
Angle of operation	50 mm – 2 000 mm (1,9 – 78,7 in)	<b>Battery type TMRT 1 Ex</b>	Only use 4 × Duracell "Procell" AAA cells
Light source	$\pm 80^\circ$	<b>Unit dimensions</b>	213 × 40 × 39 mm (8,3 × 1,5 × 1,5 in)
Accuracy speed modes only	Class II laser diode	<b>Unit weight</b>	170 g (5,9 oz)
	0,01%, $\pm 1$ digit	<b>Carrying case dimensions</b>	238 × 49 × 102 mm (9,3 × 1,9 × 4,0 in)
		<b>Total weight (incl. case)</b>	355 g (12,5 oz)
		<b>Warranty</b>	12 months
		<b>Intrinsically safe classification (TMRT 1Ex only)</b>	II 2 G EEx ia IIC T4
		<b>EC Type Examination Certificate</b>	Baseefa03ATEX0425X

## Product and accessories ordering details

Designation	Description
TMRT 1	Multi function laser and contact tachometer
TMRT 1Ex	Intrinsically safe multi function laser and contact tachometer
TMRT 1-56	Laser remote sensor, for TMRT 1 only $\varnothing 22 \times 65$ mm (0,8 × 2,5 in)
TMRT 1-60	Bracket for laser remote sensor

## TMST 2 (page 87)

Designation	TMST 2		
Frequency range	30 Hz – 15 kHz	<b>Battery</b>	9V Alkaline IEC 6LR61
Operating temperature	0 – 45 °C (32 – 113 °F)	<b>Battery lifetime</b>	Approx. 20 hours; low battery indication
Output volume	Adjustable	<b>Dimensions</b>	190 × 60 × 30 mm (7,5 × 2,4 × 1,2 in)
Minimum recorder impedance	1 000 Ohm	<b>Weight (instrument)</b>	200 g (7 oz)
Maximum recorder output	250 mV	<b>Weight (headset)</b>	250 g (9 oz)
Headset	8 Ohm Piezo type (with ear defender)		

## Part ordering details

Designation	Description
TMST 2	Electronic stethoscope
TMST 2-1	Handset complete
TMST 2-2A	High quality headset
TMST 2-3	Probe set

## TMEH 1 (page 87)

Designation	TMEH 1		
Suitable oil types	mineral and synthetic oils	<b>Battery</b>	9V Alkaline IEC 6LR61
Repeatability	better than 5%	<b>Battery lifetime</b>	> 150 hours or 3 000 tests
Read-out	green/red grading + numerical value (0 – 100)	<b>Dimensions</b>	250 × 95 × 32 mm (instrument) (9,8 × 3,7 × 1,3 in)

## Part ordering details

Designation	Description
TMEH 1	OilCheck monitor

## CMVP series (page 88)

Designation	CMVP 40 / CMVP 50		
Vibration pick-up	Piezo electric acceleration integrated sensor (compression type)	<b>Hold indication</b>	HOLD
Measurement range	1 to 55,0 mm/s (RMS) 0,06 to 3,00 in/s (eq. Peak)	<b>Power</b>	2 × CR2032 lithium batteries
Tolerance:	± 10% and 2 digits measured at 80Hz (2 digits)	<b>Battery lifetime</b>	170 mA hours current consumption Measurement mode: 7,5 mA HOLD mode 3,0 mA
Frequency range	Overall vibration – 10 Hz to 1 000 Hz (tolerance measured within the frequency range are in accordance with ISO 3945 and 2 digits) acceleration enveloping – 10 kHz to 30 kHz	<b>Auto power off function</b>	Power is turned off Approximately 2 minutes after last ON or HOLD operation
Display	Measurement value: 3,5 digit LCD	<b>Dimensions</b>	17,8 × 30,5 × 157,5 mm (0,7 × 1,2 × 6,2 in)
Display cycle	Approximately 1 second	<b>Weight</b>	approximately 77 g (2,7 oz) with batteries
Overload indication	OVER	<b>Ambient operating conditions</b>	–10 to 50 °C (14 to 122 °F) 20 to 90% relative humidity
Battery replacement indication	BATT		

## Part ordering details

Designation	Description
CMVP 40	in/s eq. peak
CMVP 50	mm/s RMS

## TMMA series (page 96)

Designation	TMMA 60	TMMA 80	TMMA 120
<b>General</b>			
Width of grip external, minimum	36 mm (1,4 in)	52 mm (2,0 in)	75 mm (3,0 in)
Width of grip external, maximum	150 mm (5,9 in)	200 mm (7,8 in)	250 mm (9,8 in)
Effective arm length	150 mm (5,9 in)	200 mm (7,8 in)	250 mm (9,8 in)
Maximum withdrawal force	60 kN (6,7 ton US)	80 kN (9,0 ton US)	120 kN (13,5 ton US)
Total weight	4,0 kg (8,8 lb)	5,7 kg (12,6 lb)	10,6 kg (23,4 lb)
<b>Claw dimensions</b>			
Claw height	7,5 mm (0,30 in)	9,8 mm (0,39 in)	13,8 mm (0,54 in)
Claw length	15 mm (0,6 in)	18 mm (0,7 in)	24 mm (0,9 in)
Claw width	20 mm (0,8 in)	28 mm (1,1 in)	40 mm (1,6 in)
<b>Force generators</b>			
Hexagon on puller or adapter	27 mm	30 mm	32 mm
Hexagon on mechanical spindle	17 mm	22 mm	24 mm
Max torque	105 Nm (75 lbf ft)	175 Nm (125 lbf ft)	265 Nm (195 lbf ft)
Diameter nose piece	24 mm (0,9 in)	26 mm (1,0 in)	28 mm (1,1 in)
Adapter: possible to upgrade to hydraulic version	no	yes	yes
<b>Spare parts</b>			
Arm	TMMA 60-1	TMMA 80-1	TMMA 120-1
Spindle with nose piece (and adapter)	TMMA 60-2	TMMA 80-2	TMMA 120-2
Opening mechanism	TMMA 60-3	TMMA 75H/80-3	TMMA 100H/12-3
<b>Accessories</b>			
Puller protection blanket	TMMX 210	TMMX 280	TMMX 350
Gloves	TMBA G11W	TMBA G11W	TMBA G11W
Hydraulic spindle	–	TMHS 75	TMHS 100
Spindle grease	LGEV 2/0.035	LGEV 2/0.035	LGEV 2/0.035
Tri- section pulling plates	TMMS 50	TMMS 50 / TMMS 100	TMMS 50 / TMMS 100 / TMMS 160

## TMHS 75 and TMHS 100 (page 98)

Designation	TMHS 75	TMHS 100
<b>Contents</b>	1 × hydraulic spindle 2 × extension pieces; 50 and 100 mm (2,0 and 3,9) 1 × nosepiece	1 × hydraulic spindle 3 × extension pieces; 50, 100 and 150 mm (2,0, 3,9 and 5,9 in) 1 × nosepiece
<b>Maximum withdrawal force</b>	75 kN (8,4 ton US)	100 kN (11,2 ton US)
<b>Piston stroke</b>	75 mm (3,0 in)	80 mm (3,1 in)
<b>Body thread</b>	UN 1½ × 12	UN 1½ × 16
<b>Nose piece diameter</b>	35 mm (1,4 in)	30 mm (1,2 in)
<b>Maximum reach</b>	204 mm (8,0 in)	354 mm (13,9 in)
<b>Weight</b>	2,7 kg (6,0 lb)	4,5 kg (10,0 lb)



# Technical data



## TMMA H series (page 96)

Designation	TMMA 75H	TMMA 100H
<b>General:</b>		
Width of grip external, minimum	52 mm (2 in)	75 mm (3 in)
Width of grip external, maximum	200 mm (7,8 in)	250 mm (9,8 in)
Effective arm length	200 mm (7,8 in)	250 mm (9,8 in)
Maximum withdrawal force	75 kN (8,4 ton US)	100 kN (11,2 ton US)
Total weight	7,2 kg (15,9 lb)	13,2 kg (29 lb)
<b>Claw Dimensions</b>		
Claw height	9,8 mm (0,39 in)	13,8 mm (0,54 in)
Claw length	18 mm (0,7 in)	24 mm (0,9 in)
Claw width	28 mm (1,1 in)	40 mm (1,6 in)
<b>Force generator</b>		
Hydraulic spindle	TMHS 75	TMHS 100
Piston stroke	75 mm (3,0 in)	80 mm (3,1 in)
Body thread	UN 1,25" x 12	UN 1,5" x 16
Diameter nose piece	35 mm (1,4 in)	30 mm (1,2 in)
<b>Spare parts</b>		
Arm	TMMA 75H-1	TMMA 100H-1
Opening mechanism	TMMA 75H/80-3	TMMA 100H/12-3
Hydraulics extension piece set	TMHS 5T	TMHS 8T
<b>Accessories</b>		
Hydraulic spindle	TMHS 75 (included)	TMHS 100 (included)
Puller protection blanket	TMMX 280	TMMX 350
Gloves	TMBA G11W	TMBA G11W
Tri section pulling plates	TMMS 50 TMMS 100	TMMS 50 TMMS 100 TMMS 160

## TMMA 100H/SET (page 97)

Designation	TMMA 100H/SET		
<b>General</b>		<b>Max diameter</b>	350 mm (13,8 in)
Width of grip external, minimum	75 mm (3 in)	<b>Length</b>	1200 mm (47 in)
Width of grip external, maximum	250 mm (9,8 in)	<b>Width</b>	580 mm (19 in)
Effective arm length	250 mm (9,8 in)	<b>Weight</b>	0,6 kg (1,4 lb)
Maximum withdrawal force	100 kN (11,2 ton US)	<b>Case</b>	
<b>Claw dimensions</b>		<b>Height</b>	270 mm (11 in)
Claw height	13,8 mm (0,54 in)	<b>Length</b>	680 mm (27 in)
Claw length	24 mm (0,9 in)	<b>Width</b>	320 mm (13 in)
Claw width	40 mm (1,6 in)	<b>Weight</b>	12,0 kg (26,5 lb)
<b>Force generator</b>		<b>Spare parts</b>	
Hydraulic spindle	TMHS 100	Arm	TMMA 100H-1
Piston stroke	80 mm (3,1 in)	Opening mechanism	TMMA 100H/12-3
Body thread	UN 1,5"x16	Hydraulic extension piece set	TMHS 8T
Diameter nose piece	30 mm (1,2 in)	<b>Accessories</b>	
Tri-section pulling plate	TMMS 160	Puller protection blanket	TMMX 350 (included)
Width of grip shaft, minimum	50 mm (2,0 in)	Hydraulic spindle	TMHS 100 (included)
Width of grip shaft, maximum	160 mm (6,3 in)	Tri section pulling plates	TMMS 160 (included)
Weight	5,9 kg (13,0 lb)	Gloves	TMBA G11W
Puller protection blanket	TMMX 350		

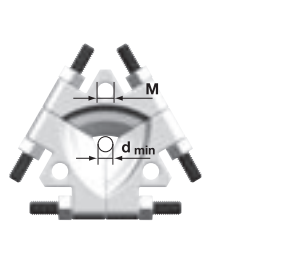
## TMMS series (page 97)

Designation	Width of grip				M		
	d min		d max				
	mm	in	mm	in	mm		
TMMS 50	12	0,5	50	2,0	-		
TMMS 100	26	1,0	100	3,9	M16 x 2		
TMMS 160	50	2,0	160	6,3	M16 x 2		
TMMS 260	90	3,6	260	10,2	M22 x 2,5		
TMMS 380	140	5,5	380	15,0	M32 x 2,5		

Designation	A		B		C		Maximum Withdrawal Force (F max)		Weight		
	mm	in	mm	in	mm	in	kN	ton US	kg	lb	
TMMS 50	20	0,8	-	-	32	1,3	80	9	0,5	1,1	
TMMS 100	36	1,4	34	1,4	60	2,4	200	23	2,6	5,7	
TMMS 160	45	1,8	52	2,1	82	3,3	300	34	5,9	13	
TMMS 260	70	2,8	81	3,2	110	4,3	450	51	18,4	41	
TMMS 380	81	3,2	97	3,8	138	5,4	600	68	50,3	110	

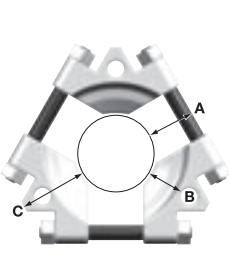
**TMMP series** (page 99)

Designation	No. of arms qty	Width of grip		Effective length of arms		Maximum withdrawal force		Weight	
		mm	in	mm	in	kN	ton US	kg	lb
TMMP 2x65	2	15 – 65	0,6 – 2,6	60	2,4	6,0	0,7	0,5	1,2
TMMP 2x170	2	25 – 170	1,0 – 6,7	135	5,3	18,0	2,0	2,1	4,7
TMMP 3x185	3	40 – 185	1,6 – 7,3	135	5,3	24,0	2,7	2,9	6,4
TMMP 3x230	3	40 – 230	1,6 – 9,1	210	8,3	34,0	3,8	5,8	13
TMMP 3x300	3	45 – 300	1,8 – 11,8	240	9,4	50,0	5,6	8,6	19

**TMMR F series** (page 99)

Designation	Width of grip external pull		Width of grip internal pull		Effective arm length		Maximum withdrawal force		Weight	
	mm	in	mm	in	mm	in	kN	ton US	kg	lb
TMMR 40F	23 – 48	0,9 – 1,9	59 – 67	2,3 – 2,6	65	2,6	15	1,7	0,3	0,8
TMMR 60F	23 – 68	0,9 – 2,7	62 – 87	2,4 – 3,4	80	3,2	15	1,7	0,4	0,8
TMMR 80F	41 – 83	1,6 – 3,3	93 – 97	3,7 – 3,8	94	3,7	30	3,4	1,0	2,2
TMMR 120F	41 – 124	1,6 – 4,8	93 – 138	3,7 – 5,4	120	4,7	30	3,4	1,2	2,6
TMMR 160F	68 – 164	2,7 – 6,5	114 – 162	4,5 – 6,4	130	5,1	40	4,5	2,3	5,2
TMMR 200F	67 – 204	2,6 – 8,0	114 – 204	4,5 – 8,0	155	6,1	40	4,5	2,6	5,8
TMMR 250F	74 – 254	2,9 – 10,0	132 – 252	5,2 – 9,9	178	7,0	50	5,6	4,4	9,7
TMMR 350F	74 – 354	2,9 – 14,0	135 – 352	5,3 – 13,8	233	9,2	50	5,6	5,2	11,5
TMMR 8	Complete kit of 8 pullers on a counter stand									

**TMMP series** (page 100)

Designation	No. of arms qty	Width of grip		Effective length of arms*		Maximum withdrawal force		Weight	
		mm	in	mm	in	kN	ton US	kg	lb
TMMP 6	3	50 – 127	2,0 – 5,0	120	4,7	60	6,7	4,0	8,8
TMMP 10	3	100 – 223	3,9 – 8,7	207	8,2	100	11,2	8,5	19
TMMP 15	3	140 – 326	5,5 – 12,8	340	13,4	150	17,0	21,5	46

\* other arm lengths available according to part ordering details

**Part ordering details**

No.	Designation	Description	TMMP 6		TMMP 10		TMMP 15	
			mm	in	mm	in	mm	in
1	TMMP ...-1	Arm-length	120	4,7	207	8,2	260	10,2
2	TMMP ...-2	Arm-length	220	8,6	350	13,8	340	13,4
3	TMMP ...-3	Arm-length	370	14,5	460	18,1	435	17,1
4	TMMP ...-4	Arm-length	470	18,5	710	27,9	685	27,0
5	TMMP ...-5	Spindle with centre nib						
6	TMMP ...-1K	Stand, boss and complete set of pins, bolts and link arms (per arm)						

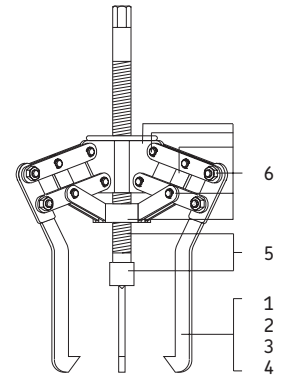
**TMHP 10E** (page 101)

Designation	TMHP 10E	
Description	Advanced hydraulic jaw puller kit	<b>Arm set 1 (3 × TMHP 10E-10)</b>
Contents	1 × arm-assembly stand 3 × arms, 120 mm (4,7 in) 3 × arms, 170 mm (6,7 in) 3 × arms, 200 mm (7,8 in) 1 × hydraulic spindle TMHS 100 3 × extension pieces for hydraulic spindle; 50, 100, 150 mm (2, 4, 6 in) 1 × nosepiece with centre point for hydraulic spindle	<b>Effective arms length</b> <b>Width of grip</b> <b>Claw dimensions</b>
Maximum stroke	80 mm (3,1 in)	120 mm (4,7 in) 75 – 170 mm (3,0 – 6,7 in) a = 6 mm (0,2 in) b = 15 mm (0,6 in) c = 25 mm (1 in)
Weight complete kit	14,5 kg (32 lb)	<b>Arm set 2 (3 × TMHP 10E-11)</b>
Cycle life hydraulic cylinder	Minimum 5 000 cycles up to 100 kN (11,2 US ton force)	<b>Effective arms length</b> <b>Width of grip</b> <b>Claw dimensions</b>
Threading hydraulic cylinder	UN 1½" × 16 tpi	170 mm (6,7 in) 80 – 250 mm (3,1 – 9,8 in) a = 6 mm (0,2 in) b = 12 mm (0,5 in) c = 25 mm (1 in)
Safety valve setting hydraulic cylinder	105 kN (11,8 US ton force)	<b>Arm set 3 (3 × TMHP 10E-12)</b>
Carrying case dimensions	578 × 410 × 70 mm (23 × 16 × 2,8 in)	<b>Effective arms length</b> <b>Width of grip</b> <b>Claw dimensions</b>
Nominal working force	100 kN (11,2 US ton force)	200 mm (7,8 in) 110 – 280 mm (4,3 – 11 in) a = 6 mm (0,2 in) b = 12 mm (0,5 in) c = 25 mm (1 in)

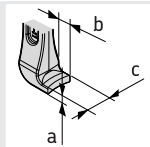
**Part ordering details**

Designation	Description	Designation	Description
TMHS 100	Advanced hydraulic spindle, 100 kN	TMHP 10E-10	120 mm arm (4,7 in)
TMHS 8T	Set of extension pieces and nose piece for the hydraulic spindle	TMHP 10E-11	170 mm arm (6,7 in)
TMHP 10E-5	Arm-assembly stand, centre, bolts and nuts	TMHP 10E-12	200 mm arm (7,8 in)

# Technical data

## TMHP series (page 100)

Designation*	No. of arms	Width of grip		Effective length of arms		Stroke		Maximum working pressure		Maximum withdrawal force		Weight	
		qty	mm	in	mm	in	mm	in	MPa	psi	kN	ton US	kg
TMHP 15/260	3	195-386	7,7-15,2	264	10,4	100	3,9	80	11,600	150	16,9	34	75
TMHP 30/170	3	290-500	11,4-19,7	170	6,7	50	2,0	80	11,600	300	33,7	45	99
TMHP 30/350	3	290-500	11,4-19,7	350	13,7	50	2,0	80	11,600	300	33,7	47	104
TMHP 30/600	3	290-500	11,4-19,7	600	23,6	50	2,0	80	11,600	300	33,7	56	123
TMHP 50/140	3	310-506	12,2-19,9	140	5,5	40	1,6	80	11,600	500	56,2	47	104
TMHP 50/320	3	310-506	12,2-19,9	320	12,6	40	1,6	80	11,600	500	56,2	54	119
TMHP 50/570	3	310-506	12,2-19,9	570	22,4	40	1,6	80	11,600	500	56,2	56	123

\*Also available without hydraulic pump TMJL 100. Please add suffix 'X' to designation when ordering (e.g. TMHP 30/170X)

## TMHP series (page 100)

Designation	Hydraulic pump TMJL 100
Maximum pressure	100 MPa (14 500 psi)
Volume/stroke	1 cm <sup>3</sup> (0,06 in <sup>3</sup> )
Oil container capacity	800 cm <sup>3</sup> (48 in <sup>3</sup> )
Pressure hose	3 000 mm (118,1 in) long with quick connection coupling and nipple G 1/4 internal/external thread
Weight with gauge	13 kg (29 lb)
Oil type	filled with SKF LHM 300

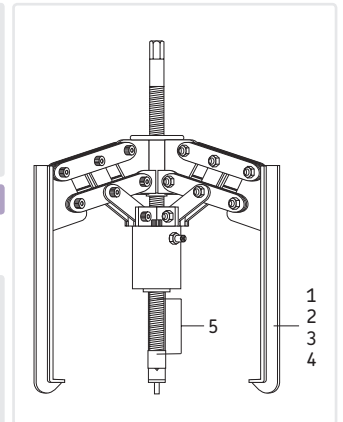

## Part ordering details

No.	Designation	Description	TMHP 15		TMHP 30		TMHP 50	
			mm	in	mm	in	mm	in
1	TMHP ...-1	Arm-length	264	10,4	170	6,7	140	5,5
2	TMHP ...-2	Arm-length	344	14,2	350	13,7	320	12,6
3	TMHP ...-3	Arm-length	439	17,3	600	23,6	570	22,4
4	TMHP ...-4	Arm-length	689	27,1				
5	TMHP ...-5	Spindle with centre nib						
	TMHP ...-11	Repair kit for hydraulic cylinder						

## TMHC 110E (page 101)

Designation	TMHC 110E
Description	Advanced hydraulic puller kit
Contents	1 × arm-assembly stand 3 × arms, 70 mm (2,7 in) 3 × arms, 120 mm (4,7 in) 1 × separator set 1 × beam 2 × main rods 2 × extension rods, 125 mm (4,9 in) 1 × hydraulic spindle TMHS 100 2 × extension pieces for hydraulic spindle; 50, 100 mm (2,0, 3,9 in) 1 × nosepiece with centre point for hydraulic spindle
Maximum stroke	80 mm (3,1 in)
Nominal working force	100 kN (11,2 US ton force)
Cycle life hydraulic cylinder	Minimum 5 000 cycles up to 100 kN (11,2 US ton force)
Threading hydraulic cylinder	UN 1½" × 16 tpi
Safety valve setting hydraulic cylinder	105 kN (11,8 US ton force)
Carrying case dimensions	580 × 410 × 70 mm (23 × 16 × 2,8 in)
Weight	13,5 kg (29,8 lb)
Jaw puller:	
Arms set 1 (TMHP 10E-9)	
Effective arms length	70 mm (2,7 in)
Width of grip, arms set 1	50 - 110 mm (2 - 4,3 in)
Claw dimensions	a = 5 mm (0,2 in) b = 15 mm (0,6 in) c = 25 mm (1 in)
Arms set 2 (TMHP 10E-10)	
Effective arms length	120 mm (4,7 in)
Width of grip, arms set 2	75 - 170 mm (3,0 - 6,7 in)
Claw dimensions	a = 6 mm (0,2 in) b = 15 mm (0,6 in) c = 25 mm (1 in)
Strong back puller:	
Maximum reach	255 mm (10 in)
Shaft diameter range	20 - 100 mm (0,8 - 4 in)

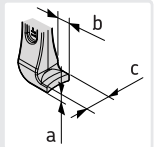

## Part ordering details

Designation	Description		
TMHP 10E-5	Arm-assembly stand, centre, bolts and nuts		
TMHP 10E-9	70 mm (2,7 in) arm		
TMHP 10E-10	120 mm (4,7 in) arm		
TMBS 100E-1	Beam		
TMBS 100E-2	Main rods, washers and nuts		
TMBS 100E-3	Extension rods (2 pcs) 125 mm (4,9 in)		
TMBS 100E-5	Separator set, bolts and nuts (100 mm / 4 in)		
TMHS 100	Advanced hydraulic spindle, 100 kN		
TMHS 8T	Set of extension pieces and a nose piece for the hydraulic spindle		

## TMMX series (page 105)

Designation	Recommended maximum diameter		Length		Width		Length of strap		No. of strap	Buckle size
	mm	in	mm	in	mm	in	mm	in		
TMMX 210	210	8,3	750	29,5	420	16,5	500	19,7	3	1
TMMX 280	280	11,0	970	38,2	480	18,9	520	20,5	3	1
TMMX 350	350	13,8	1 200	47,2	580	22,8	770	30,3	3	1 1/2

## TMBS 50E (page 102)

<b>Designation</b>	<b>TMBS 50E</b>		
<b>Description</b>	Mechanical strong back puller	<b>Maximum reach</b>	110 mm (4,3 in)
<b>Contents</b>	1 × separator set 1 × mechanical spindle 1 × beam 2 × main rods	<b>Shaft diameter range</b> <b>Maximum torque (T)</b> <b>Spindle Hexagon head (AF)</b> <b>Carrying case dimensions</b>	7 – 50 mm (0,3 – 2 in) 70 Nm (50 lbf ft) 19 mm (0,8 in) 295 × 190 × 55 mm (11,6 × 7,5 × 2 in)
<b>Nominal working force</b>	30 kN (3,4 US ton force)	<b>Weight</b>	1,8 kg (4 lb)

## Part ordering details

Designation	Description
TMBS 50E-1	Beam
TMBS 50E-2	Spindle
TMBS 50E-1K	Main rods, washers (4 pcs), bolts and nuts (2pcs)

## TMBS E series (page 102)

Designation	TMBS 100E	Designation	TMBS 150E
<b>Description</b>	Advanced hydraulic strong back puller	<b>Description</b>	Advanced hydraulic strong back puller
<b>Contents</b>	1 × separator set 2 × main rods 2 × extension rods, 125 mm (4,9 in) 4 × extension rods, 285 mm (11,2 in) 1 × beam 1 × hydraulic spindle TMHS 100 2 × extension pieces for hydraulic spindle; 50, 100 mm (2,0, 3,9 in) 1 × nosepiece with centre point for hydraulic spindle	<b>Contents</b>	1 × separator set 2 × main rods 2 × extension rods, 125 mm (4,9 in) 4 × extension rods, 285 mm (11,2 in) 1 × beam 1 × hydraulic spindle TMHS 100 2 × extension pieces for hydraulic spindle; 50, 100 mm (2,0, 3,9 in) 1 × nosepiece with centre point for hydraulic spindle
<b>Maximum stroke</b>	80 mm (3,1 in)	<b>Maximum stroke</b>	80 mm (3,1 in)
<b>Nominal working force</b>	100 kN (11,2 US ton force)	<b>Nominal working force</b>	100 kN (11,2 US ton force)
<b>Maximum reach</b>	825 mm (32,5 in)	<b>Maximum reach</b>	825 mm (32,5 in)
<b>Shaft diameter range</b>	20 – 100 mm (0,8 – 4 in)	<b>Shaft diameter range</b>	35 – 150 mm (1,4 – 6 in)
<b>Cycle life hydraulic cylinder</b>	Minimum 5 000 cycles up to 100 kN (11,2 US ton force)	<b>Cycle life hydraulic cylinder</b>	Minimum 5 000 cycles up to 100 kN (11,2 US ton force)
<b>Threading hydraulic cylinder</b>	UN 1½" × 16 tpi	<b>Threading hydraulic cylinder</b>	UN 1½" × 16 tpi
<b>Safety valve setting hydraulic cylinder</b>	105 kN (11,8 US ton force)	<b>Safety valve setting hydraulic cylinder</b>	105 kN (11,8 US ton force)
<b>Carrying case dimensions</b>	580 × 410 × 70 mm (23 × 16 × 2,8 in)	<b>Carrying case dimensions</b>	580 × 410 × 70 mm (23 × 16 × 2,8 in)
<b>Weight</b>	13,5 kg (29,8 lb)	<b>Weight</b>	17 kg (37,5 lb)

## Part ordering details

Designation	Description
TMHS 100	Advanced hydraulic spindle, 100 kN
TMHS 8T	Set of extension pieces for the hydraulic spindle, nose piece
TMBS 100E-1	Beam
TMBS 100E-2	Main rods, nuts, washers (set)
TMBS 100E-3	Extension rods (2 pcs) 125 mm (4,9 in)
TMBS 100E-4	Extension rods (4 pcs) 285 mm (11,2 in)
TMBS 100E-5	Separator (complete)

## TMMD 100 (page 103)

Designation	L		H		E	
	mm	in	mm	in	mm	in
TMMD 100-A1	135	5,3	16	0,6	79	3,1
TMMD 100-A2	135	5,3	16	0,6	79	3,1
TMMD 100-A3	137	5,4	23	0,9	77	3,0
TMMD 100-A4	162	6,4	26	1,0	52	2,0
TMMD 100-A5	167	6,6	> 52	> 2,0	49	1,9
TMMD 100-A6	170	6,7	> 100	> 3,9	49	1,9

## Ordering details

<b>Designation</b>	<b>TMMD 100</b>
<b>Description</b>	Deep groove ball bearing puller kit
<b>Kit contents</b>	3 × puller arm TMMD 100-A1 3 × puller arm TMMD 100-A2 3 × puller arm TMMD 100-A3 3 × puller arm TMMD 100-A4 3 × puller arm TMMD 100-A5 3 × puller arm TMMD 100-A6 1 × small spindle and nut TMMD 100-S1 1 × big spindle and nut TMMD 100-S2 1 × handle
<b>Dimensions of case</b>	395 × 300 × 105 mm (15,5 × 11,8 × 4,1 in)
<b>Weight</b>	3,8 kg (8,4 lb)

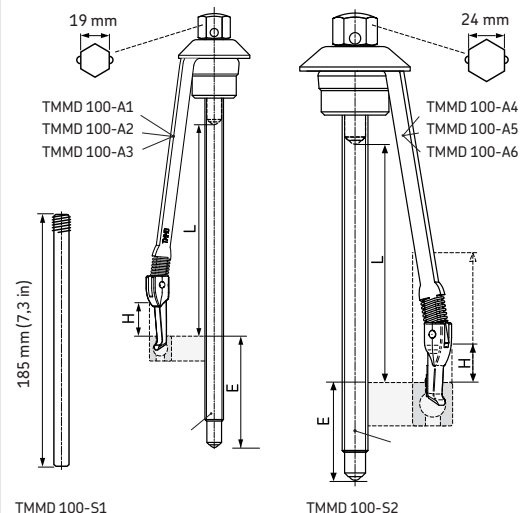

# Technical data

## TMSC series (page 104)

<b>Designation</b>	<b>TMSC 6</b>		
<b>Shaft diameter range</b>	8 – 36 mm (0,3 – 1,4 in)	<b>Total weight</b>	4,0 kg (8,8 lb)
<b>Hammer displacement</b>	220 mm (8,7 in)	<b>Dimensions of case</b>	465 × 135 × 55 mm (18 × 5 × 2 in)
<b>Weight of hammer</b>	1,0 kg (2,2 lb)		

## Part ordering details

No.	Designation	Description
1	TMSC-1	Slide hammer complete
2	TMSC-5	Adapter
3	TMSC-9	Extractor Ø 8 – 10,5 mm (0,31 – 0,41 in)
4	TMSC-10	Extractor Ø 10,5 – 12,5 mm (0,41 – 0,49 in)
5	TMSC-11	Extractor Ø 13 – 17 mm (0,51 – 0,67 in)
6	TMSC-12	Extractor Ø 18 – 22 mm (0,71 – 0,87 in)
7	TMSC-13	Extractor Ø 22,5 – 30 mm (0,89 – 1,2 in)
8	TMSC-14	Extractor Ø 30 – 36 mm (1,2 – 1,4 in)

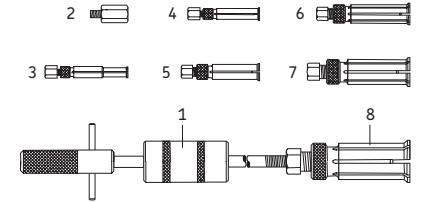

<b>Designation</b>	<b>TMSC 30-60</b>		
<b>Shaft diameter range</b>	30 – 60 mm (1,2 – 2,4 in)	<b>Weight</b>	10 kg (22 lb)
<b>Hammer displacement</b>	300 mm (11,8 in)	<b>Dimensions of case</b>	585 × 235 × 90 mm (23 × 9,3 × 3,5 in)
<b>Weight of hammer</b>	1,6 kg (3,5 lb)		

## Part ordering details

No.	Designation	Description
1	TMSC-2	Slide hammer complete
2	TMSC-14	Extractor Ø 30 – 36 mm (1,2 – 1,4 in)
3	TMSC-15	Extractor Ø 38 – 50 mm (1,5 – 2,0 in)
4	TMSC-16	Extractor Ø 50 – 60 mm (2,0 – 2,4 in)

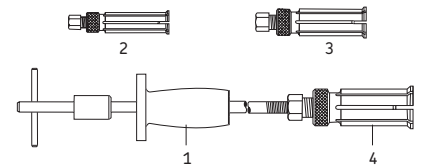

## TMBP 20E (page 105)

<b>Designation</b>	<b>TMBP 20E</b>		
<b>Effective arm length</b>	147 mm (5,8 in)	<b>Set contents</b>	Adapters size A to F (2 pcs each)
<b>Extension piece length</b>	200 mm (7,9 in)		2 x main rods (with nut support rings and nuts)
<b>Maximum arm length (incl extension pieces)</b>	583 mm (23,0 in) for adapter F		4 x extension rods
<b>Maximum pulling force</b>	55 kN (6,2 ton US)		Spindle
<b>Maximum torque</b>	155 Nm (114 lbf ft)		Spindle nose piece
<b>Spindle head AF size</b>	22 mm		Beam
<b>Dimensions of case</b>	395 × 300 × 105 mm (15,5 × 11,8 × 4,1 in)		IFU card
<b>Weight</b>	7,5 kg (16,5 lb)	<b>Spare parts</b>	Case with inlay
		TMBP 20E-1	Spindle with nose piece
		<b>Accessories</b>	
		TMBA G11W	Gloves
		LEGV 2/0.0035	Spindle grease
		TMMX 280	Puller protection blanket

## Selection chart TMBP 20E

Bearing adapter	A	B	C	D	E	F
Spanner size for mounting	9 mm	11 mm	14 mm	15 mm	17 mm	19 mm
Ball adapter size	16 mm	19 mm	23,5 mm	26,5 mm	28 mm	30 mm
<b>Bearing series</b>						
60..	6021 6022 6024	6026 6028 6030	6032			
62..	6213 6214 6215 6216	6217 6218	6219 6220	6221	6222 6224 6226 6228 6230 6232	
63..	6309	6310 6311 6312	6313 6314 6321	6315 6316	6317 6318	6319 6320
64..	6406	6407 6408 6409	6410	6411 6412	6413	6414 6415 6416 6417 6418
160..		16026 16028 16030 16032				

**EAZ series** (page 107)

Heater designation	Voltage class	Bearing designation	Coil Current consumption	Connecting cable	Control cabinet	Dimensions ring				Dimensions heater			
						d	B	F	G	C	D	A	
						mm	mm	mm	mm	mm	mm	mm	
EAZ 166	LV	314625	170	A07 RN - F 3 × 25	SS 250	145 p6	155	166	169	350	370	176	
	MV		100										A07 RN - F 3 × 16
	HV		75										A07 RN - F 3 × 16
EAZ 169	LV	313924 A	170	A07 RN - F 3 × 25	SS 250	145 p6	156	169	172	355	378	176	
	MV		100										A07 RN - F 3 × 16
	HV		75										A07 RN - F 3 × 16
EAZ 174	LV	313891 A	165	A07 RN - F 3 × 25	SS 250	150 p6	156	174	177	360	388	176	
	MV		95										A07 RN - F 3 × 16
	HV		75										A07 RN - F 3 × 16
EAZ 179	LV	315189 A	180	A07 RN - F 3 × 35	SS 250	160 p6	168	179	182	355	378	184	
	MV		105										A07 RN - F 3 × 16
	HV		80										A07 RN - F 3 × 16
EAZ 180	LV	314190	150	A07 RN - F 3 × 25	SS 250	160 p6	130	180	183	365	390	151	
	MV		85										A07 RN - F 3 × 16
	HV		65										A07 RN - F 3 × 16
EAZ 181	LV	315642/ VJ202	180	A07 RN - F 3 × 35	SS 250	165,1 p6	165	181	184	355	378	190	
	MV		105										A07 RN - F 3 × 16
	HV		80										A07 RN - F 3 × 16
EAZ 190	LV	BC4B 635122	140	A07 RN - F 3 × 25	SS 250	170 p6	130	190	193	375	402	151	
	MV		80										A07 RN - F 3 × 16
	HV		60										A07 RN - F 3 × 16
EAZ 202	LV	313812	165	A07 RN - F 3 × 25	SS 250	180 p6	168	202	205	375	402	190	
	MV		95										A07 RN - F 3 × 16
	HV		70										A07 RN - F 3 × 16
EAZ 212	LV	314199 B	200	A07 RN - F 3 × 35	SS 250	190 p6	200	212	215	385	412	217	
	MV		115										A07 RN - F 3 × 25
	HV		90										A07 RN - F 3 × 16
EAZ 222-1	LV	314553	190	A07 RN - F 3 × 35	SS 250	200 p6	170	222	225	385	412	190	
	MV		110										A07 RN - F 3 × 16
	HV		85										A07 RN - F 3 × 16
EAZ 222-2	LV	313893	215	A07 RN - F 3 × 25	SS 250	200 p6	200	222	225	395	422	217	
	MV		125										A07 RN - F 3 × 16
	HV		95										A07 RN - F 3 × 16
EAZ 226	LV	313811	210	A07 RN - F 3 × 35	SS 250	200 p6	192	226	229	400	425	213	
	MV		120										A07 RN - F 3 × 25
	HV		95										A07 RN - F 3 × 16
EAZ 244	LV	313894 B	300	A07 RN - F 3 × 50	SS 350	220 r6	225	244	247	410	435	247	
	MV		175										A07 RN - F 3 × 35
	HV		130										A07 RN - F 3 × 25
EAZ 246	LV	313839	260	A07 RN - F 3 × 50	SS 350	220 r6	192	246	249	410	435	214	
	MV		150										A07 RN - F 3 × 25
	HV		115										A07 RN - F 3 × 25
EAZ 260	LV	313824	275	A07 RN - F 3 × 50	SS 350	230 r6	206	260	263	425	450	227	
	MV		160										A07 RN - F 3 × 25
	HV		120										A07 RN - F 3 × 35
EAZ 265	LV	635194	240	A07 RN - F 3 × 35	SS 250	240 r6	180	265	268	430	457	201	
	MV		140										A07 RN - F 3 × 25
	HV		105										A07 RN - F 3 × 16
EAZ 270	LV	313921	265	A07 RN - F 3 × 50	SS 350	240 r6	220	270	273	435	460	233	
	MV		155										A07 RN - F 3 × 25
	HV		115										A07 RN - F 3 × 25
EAZ 292	LV	313823	295	A07 RN - F 3 × 50	SS 350	260 r6	220	292	295	445	470	240	
	MV		170										A07 RN - F 3 × 25
	HV		130										A07 RN - F 3 × 25
EAZ 308	LV	314719 C	335	A07 RN - F 3 × 50	SS 350	280 r6	275	308	311	460	490	296	
	MV		195										A07 RN - F 3 × 35
	HV		145										A07 RN - F 3 × 25
EAZ 312	LV	313822	285	A07 RN - F 3 × 50	SS 350	280 r6	220	312	315	465	490	238	
	MV		165										A07 RN - F 3 × 25
	HV		125										A07 RN - F 3 × 25
EAZ 332	LV	314484 D	365	A07 RN - F 3 × 70	SS 350	300 r6	300	332	335	480	500	322	
	MV		210										A07 RN - F 3 × 35
	HV		160										A07 RN - F 3 × 25
EAZ 378	LV	314485 A	375	A07 RN - F 3 × 70	SS 350	340 r6	350	378	381	525	555	368	
	MV		240										A07 RN - F 3 × 50
	HV		205										A07 RN - F 3 × 35

# Technical data

## Voltage classification EAZ series

Each heater is available in three different voltage versions as follows:

LV	Low	190 to 230V
MV	Medium	400 to 480V
HV	High	500 to 575V

Please add the corresponding class as a suffix to the designation when ordering (e.g. EAZ 166 HV).

## Control cabinets EAZ series

Designation		Designation	
SS 250A	230V, 50Hz, 250A	SS 250B	400V, 50Hz, 250A
SS 250C	460V, 60Hz, 250A	SS 350A	230V, 50Hz, 350A
SS 350B	400V, 50Hz, 350A	SS 350C	460V, 60Hz, 350A
A special control cabinet suitable for handling two heaters at the same time is also available.			
SSD 350A	230V, 50Hz, 350A (2x)	SSD 350B	400V, 50Hz, 350A (2x)
SSD 350C	460V, 60Hz, 350A (2x)		

## EAZ series (page 107)

Designation		EAZ 80/130		EAZ 130/170	
Connection cable	Length	5 m	16 ft	5 m	16 ft
Dimensions	A	285 mm	11,2 in	335 mm	13,2 in
	B	115 mm	4,5 in	120 mm	4,7 in
	C	555 mm	21,8 in	630 mm	24,8 in
	D	305 ... 360 mm	12,0 ... 14,1 in	335 ... 380 mm	13,2 ... 15,0 in
	a	134 mm	5,3 in	180 mm	7,1 in
	b	50 mm	2,0 in	50 mm	2,0 in
	c	35 mm	1,4 in	30 mm	1,2 in
	d	80 ... 132 mm	3,1... 5,2 in	130 ... 172 mm	5,1 ... 6,8 in
Weight		28 kg	62 lb	35 kg	77 lb

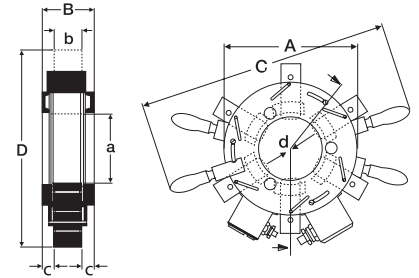

## Part ordering details

Designation	Powersupply	Current	Designation	Powersupply	Current
EAZ 80/130A	2 × 230V/50Hz	40 A	EAZ 130/170D	3 × 230V/50Hz	43 A
EAZ 80/130B	2 × 400V/50Hz	45 A	EAZ 130/170E	3 × 400V/50Hz	35 A
EAZ 80/130C	2 × 460V/60Hz	25 A	EAZ 130/170F	3 × 460V/60Hz	23 A
EAZ 80/130D	2 × 415V/50Hz	35 A	EAZ 130/170G	3 × 420V/60Hz	30 A
EAZ 130/170A	2 × 230V/50Hz	60 A	EAZ 130/170H	3 × 415V/50Hz	30 A
EAZ 130/170B	2 × 400V/50Hz	45 A			

## TMBR series (page 106)

Designation TMBR Bearing designation; (e.g. TMBR NU216E)

Material Aluminium  
Maximum temperature 300 °C (572 °F)

© Copyright SKF 2006

The contents of this publication are the copyright of the publisher and may not be reproduced (even extracts) unless permission is granted. Every care has been taken to ensure the accuracy of the information contained in this publication but no liability can be accepted for any loss or damage whether direct, indirect or consequential arising out of use of the information contained herein.

© SKF is a registered trademark of the SKF Group.

Publication MP3000E

**Concept, text, graphic design and production:**  
SKF Maintenance Products, Nieuwegein, The Netherlands

**Photography:**  
Yves Paternoster, Amsterdam, The Netherlands  
(and others)

**Printing:**  
Verweij Printing, Mijdrecht, The Netherlands

This catalogue was printed on elementary chlorine – free paper.

**SKF on internet:**  
[www.mapro.skf.com](http://www.mapro.skf.com)  
[www.skf.com/mount](http://www.skf.com/mount)  
[www.skf.com](http://www.skf.com)

# Designation index

Designation	Description	Page	TD	Designation	Description	Page	TD
1008593 E	Nipple with pipe thread (G)	35	124	HMV 10E - 200E	Hydraulic nuts	26 & 109	118
1009030 B	Nipple with pipe thread (G)	35	124	HMV 10E - 200E/A101	Hydraulic nuts without threads	26 & 109	121
1009030 E	Nipple with pipe thread (G)	35	124	HMVA 42/200	Hydraulic nut drive-up adapter	25	-
1012783 E	Nipple with pipe thread (G)	35	124	HMVC 10E - 190E	Hydraulic nuts, inch thread series	26 & 109	120
1014357 A	Nipple with pipe thread (G)	35	124	HN 0 - HN 22	Hook spanners	13	114
1016402 E	Nipple with pipe thread (G)	35	124	HN 5/SNL - HN 32/SNL	Hook spanners for SNL housings	14	116
1018219 E	Nipple with pipe thread (G)	35	124	HNA 1-4 - HNA 14-24	Adjustable hook spanners	13	115
1019950	Nipple with pipe thread (G)	35	124	LAGD 125	SYSTEM 24 automatic lubricator	66	127
1020612 A	High pressure pipe	34	123	LAGD 400	SYSTEM MultiPoint automatic lubricator	71	127
1030816 E	Plug for oil ducts and vent holes	34	123	LAGD 60	SYSTEM 24 automatic lubricator	66	127
1077453	Extension pipe	36	125	LAGF 18	Grease filler pump	75	131
1077454	Connection nipple	36	125	LAGF 50	Grease filler pump	75	131
1077455	Nipple with pipe thread (G)	35	124	LAGG 180AE	Grease pump	75	131
1077456	Nipple with pipe thread (G)	35	124	LAGG 18AE	Mobile grease pump	75	131
1077587	Pressure gauge	34	123	LAGG 18M	Grease pump	75	131
1077587/2	Pressure gauge	34	123	LAGG 1M	Grease pump	76	131
1077589	Pressure gauge	34	123	LAGG 50AE	Grease pump	75	131
1077589/2	Pressure gauge	34	123	LAGH 400	Grease gun	73	130
1077600	Grease gun	73	130	LAGM 1000E	Grease meter	74	131
1077600/SET	Grease gun set	73	130	LAGN 120	Grease nipples set	76	131
1077601	Flexible hose	73	130	LAGP 400	Grease packer	72	130
226270	Screw injector	31	122	LAGS 8	Grease nozzle set	76	76
226271	Screw injector	31	122	LAGT 180	Trolley for drums	75	123
226272	Valve nipple	31	122	LAHD 1000	Oil leveller	72	130
226273	Valve nipple	31	122	LAHD 500	Oil leveller	72	130
226400	Oil injector	32	123	LGAF 3E	Anti-fret	10	130
226400/400MPa	Oil injector	32	123	LGEM 2	High viscosity grease	62	129
226402	Adapter block	33	123	LGE2	Extreme pressure grease	61	128
227957 A	High pressure pipe	34	123	LGET 2	Extreme high temperature grease	66	129
227958 A	High pressure pipe	34	123	LGEV 2	Extremely high viscosity grease	62	129
227963	Valve nipple	36	125	LGFP 2	Food compatible grease	61	128
227964	Extension pipe	36	125	LGG2	Biodegradable grease	63	129
227965	Extension pipe	36	125	LGHB 2	High viscosity, high temperature grease	65	129
228027 E	Nipple with pipe thread (G)	35	124	LGHP 2	High performance grease	65	128
233950 E	Plug for oil ducts and vent holes	34	123	LGHT 2	Low temperature, high speed grease	63	128
234063	Connection nipple	35	125	LGMT 2	All purpose grease	60	128
234064	Extension pipe	36	125	LGMT 3	All purpose grease	60	128
721740 A	High pressure pipe	34	123	LGWA 2	Wide temperature range grease	64	129
727213 A	High pressure pipe	34	123	LGWM 1	Extreme pressure, low temperature grease	64	129
728017 A	High pressure pipe	34	123	LHDF 900	Dismounting fluid	110	100
728619 E	Hydraulic pump	30	122	LHFP 150	Food compatible chain oil	69	130
729100	Quick connection nipple	35	124	LHHT 265	High temperature chain oil	69	130
729101 B	Oil injection kit	32	123	LHMF 300	Mounting fluid	36	36
729101 E	Oil injection kit	32	123	LHMT 68	Medium temperature chain oil	69	130
729106	Connection nipple (NPT and G)	35	124	LHRP 1	Anti-corrosive	38	130
729123 A	High pressure pipe	34	123	THAP 030	Air-driven pump	31	122
729124	Hydraulic pump	29	119	THAP 030/SET	Air-driven pump set	31	122
729124 A	Hydraulic pump	29	119	THAP 150	Air-driven pump	31	122
729124SRB	Hydraulic pump with digital gauge	24	118	THAP 150/SET	Air-driven pump set	31	122
729126	High pressure hose	34	124	THAP 300E	Air-driven pump	31	122
729146	Nipple with pipe thread (G)	35	124	THAP 300E/SET	Air-driven pump set	31	122
729654	Connection nipple (NPT and G)	35	124	THAP 400E	Air-driven pump	31	122
729655	Connection nipple (NPT and G)	35	124	THAP 400E/SET	Air-driven pump set	31	122
729656	Connection nipple (NPT and G)	35	124	TIH 030m	Portable induction heater	18	117
729659 C	Electric hot plate	17	117	TIH 100m	Induction heater	19	117
729831 A	Quick connection coupling	35	124	TIH 210m	Efficient induction heater	20	117
729832 A	Quick connection nipple	35	124	TIH T1	Induction heater trolley	21	118
729834	High pressure hose	34	124	TMAS series	Precision shims	46	127
729865 A	Feeler gauge	27	121	TMBA G11	Heat resistant gloves	38	125
729865 B	Feeler gauge	27	121	TMBA G11D	Disposable grease resistant gloves	74	131
729944 E	Plug for oil ducts and vent holes	34	123	TMBA G11ET	Extreme heat resistant gloves	39	125
CMAC 4200-SL	Infrared thermometer	81	-	TMBA G11H	Heat and oil resistant gloves	39	125
CMIN 400-K	Inspector 400 ultrasonic probe	88	-	TMBA G11W	Special working gloves	38	125
CMPK 200	Condition monitoring starter kit (English)	89	-	TMBH 1	SCORPIO induction heater	17	116
CMPK 210	Condition monitoring starter kit (Metric)	89	-	TMBP 20E	Blind housing puller kit	105	140
CMPK 60	Bearing analysis kit	89	-	TMBR series	Aluminium ring series	106	142
CMPK 70	Bearing analysis kit	89	-	TMBS 100E	Strong back puller	102	139
CMVL 3600-IS	MARLIN® condition detector pro IS	90	-	TMBS 150E	Strong back puller	102	139
CMVL 3850	MicroVibe P	90	-	TMBS 50E	Strong back puller	102	139
CMVP 40	Vibration pen (in/s)	88	135	TMCD 10R	Horizontal dial indicator, mm	24	118
CMVP 50	Vibration pen (mm/s)	88	135	TMCD 5P	Vertical dial indicator	24	118
DialSet 3.0	Re-lubrication calculation program	70	70	TMCD 1/2R	Horizontal dial indicator, in	24	118
EAZ 130/170 A-H	Adjustable induction heaters	107	142				
EAZ 166 - EAZ 378	Fixed induction heaters	107	141				
EAZ 80/130 A-D	Adjustable induction heaters	107	141				



# Designation index

Designation	Description	Page	TD	Designation	Description	Page	TD
TMDT 2-30	Standard surface probe	82	132	TMMP 2x65	Standard jaw puller	99	137
TMDT 2-31	Magnetic surface probe	82	132	TMMP 3x185	Standard jaw puller	99	137
TMDT 2-32	Insulated surface probe	82	132	TMMP 3x230	Standard jaw puller	99	137
TMDT 2-33	Right angle surface probe	82	132	TMMP 3x300	Standard jaw puller	99	137
TMDT 2-34	Gas and liquid probe	82	132	TMMP 6	Heavy duty jaw puller	100	137
TMDT 2-34/1.5	Gas and liquid probe	82	132	TMMR 120F	Reversible jaw puller	99	137
TMDT 2-35	Probe with sharp tip	82	132	TMMR 160F	Reversible jaw puller	99	137
TMDT 2-35/1.5	Probe with sharp tip	82	132	TMMR 200F	Reversible jaw puller	99	137
TMDT 2-36	Pipe clamp probe	82	132	TMMR 250F	Reversible jaw puller	99	137
TMDT 2-37	Extension cable	82	132	TMMR 350F	Reversible jaw puller	99	137
TMDT 2-38	Wire probe	82	132	TMMR 40F	Reversible jaw puller	99	137
TMDT 2-39	High temperature wire probe	82	132	TMMR 60F	Reversible jaw puller	99	137
TMDT 2-40	Rotating probe	82	132	TMMR 8	Reversible jaw puller set	99	137
TMDT 2-41	Non-ferrous foundry probe	82	132	TMMR 80F	Reversible jaw puller	99	137
TMDT 2-41A	Dip-element	82	132	TMMS 100	Tri-section pulling plate	97	136
TMDT 2-42	Ambient temperature probe	82	132	TMMS 160	Tri-section pulling plate	97	136
TMDT 2-43	Heavy duty surface probe	82	132	TMMS 260	Tri-section pulling plate	97	136
TMEA 1P/2.5	Laser shaft alignment tool with printer capability	45	126	TMMS 380	Tri-section pulling plate	97	136
TMEA 1PEX	Intrinsically safe laser shaft alignment tool with printer	45	126	TMMS 50	Tri-section pulling plate	97	136
TMEA 2	Laser shaft alignment tool	44	126	TMXX 210	Puller protection blanket	105	138
TMEA P1	Thermal printer	46	125	TMMX 280	Puller protection blanket	105	138
TMEB 2	Laser belt alignment tool	48	126	TMXX 350	Puller protection blanket	105	138
TMEH 1	Oil check monitor	87	134	TMRS 1	Stroboscope	85	133
TMEM 1500	SensorMount® indicator	27	120	TMRT 1	Multi-function laser and contact tachometer	84	134
TMES 1	Endoscope	86	133	TMRT 1-56	Laser remote sensor for TMRT 1	84	134
TMFN series	Impact spanners	14	115	TMRT 1-60	Bracket for laser remote sensor	84	134
TMFS series	Axial lock nut sockets	15	115	TMRT 1Ex	Intrinsically safe multi-function laser and contact tachometer	84	134
TMFT 36	Bearing fitting tool kit	11	114	TMSC 30-60	Internal bearing puller kit	104	140
TMHC 110E	Hydraulic puller kit	101	138	TMSC 6	Internal bearing puller kit	104	140
TMHK 35	Mounting & dismantling kit for OK couplings	37	37	TMST 2	Electronic stethoscope	87	134
TMHK 36	Mounting & dismantling kit for OK couplings	37	37	TMTI 300	Thermal imager	80	133
TMHK 37	Mounting & dismantling kit for OK couplings	37	37	TMTL 500	Non-contact thermometer	81	132
TMHK 38	Mounting & dismantling kit for OK couplings	37	37	TMTL 1400K	Advanced infrared and contact thermometer	82	132
TMHK 38S	Mounting & dismantling kit for OK couplings	37	37	TMTP 200	General purpose thermometer	79	132
TMHK 39	Mounting & dismantling kit for OK couplings	37	37	TMTP 200Ex	Intrinsically safe contact thermometer	79	132
TMHK 40	Mounting & dismantling kit for OK couplings	37	37	VKN 550	Bearing packer	74	131
TMHK 41	Mounting & dismantling kit for OK couplings	37	37				
TMHN 7	Lock nut spanner kit	13	114				
TMHP 10E	Hydraulic jaw puller kit	101	137				
TMHP 15	Hydraulically assisted heavy duty jaw puller	100	138				
TMHP 30	Hydraulically assisted heavy duty jaw puller	100	138				
TMHP 50	Hydraulically assisted heavy duty jaw puller	100	138				
TMHS 75	Advanced hydraulic spindle	98	135				
TMHS 100	Advanced hydraulic spindle	98	135				
TMJE 300	Oil injection set	33	122				
TMJE 400	Oil injection set	33	122				
TMJG 100D	Digital pressure gauge, MPa	34	123				
TMJL 100	Hydraulic pump	29	121				
TMJL 100SRB	Hydraulic pump with digital gauge	29	118				
TMJL 50	Hydraulic pump	30	121				
TMJL 50SRB	Hydraulic pump with digital gauge	30	118				
TMTA 60	Mechanical EasyPull jaw puller	96	135				
TMTA 75H	Hydraulic EasyPull jaw puller	96	136				
TMTA 80	Mechanical EasyPull jaw puller	96	135				
TMTA 100H	Hydraulic EasyPull jaw puller	96	136				
TMTA 100H/SET	Hydraulic EasyPull jaw puller set	97	136				
TMTA 120	Mechanical EasyPull jaw puller	96	135				
TMTD 100	Deep groove ball bearing puller kit	103	139				
TMMH 300	Bearing handling tool	15	118				
TMMH 500	Bearing handling tool	15	118				
TMMP 10	Heavy duty jaw puller	100	137				
TMMP 15	Heavy duty jaw puller	100	137				
TMMP 2x170	Standard jaw puller	99	137				



#### **Mounting and Lubrication**

Includes mechanical fitting tools, induction heaters and hydraulic equipment



#### **Alignment**

Includes shaft and belt alignment tools and machinery shims



#### **Re-lubrication**

Includes bearing greases, manual and automatic lubricators and lubrication accessories



#### **Basic Condition Monitoring**

Includes temperature, noise, speed and vibration measuring instruments



#### **Dismounting**

Includes pullers, both mechanical and hydraulic, induction heaters and hydraulic equipment



#### **SKF Maintenance Products**

© Copyright SKF 2006/02

[www.mapro.skf.com](http://www.mapro.skf.com)

[www.skf.com](http://www.skf.com)

USA #711-639